

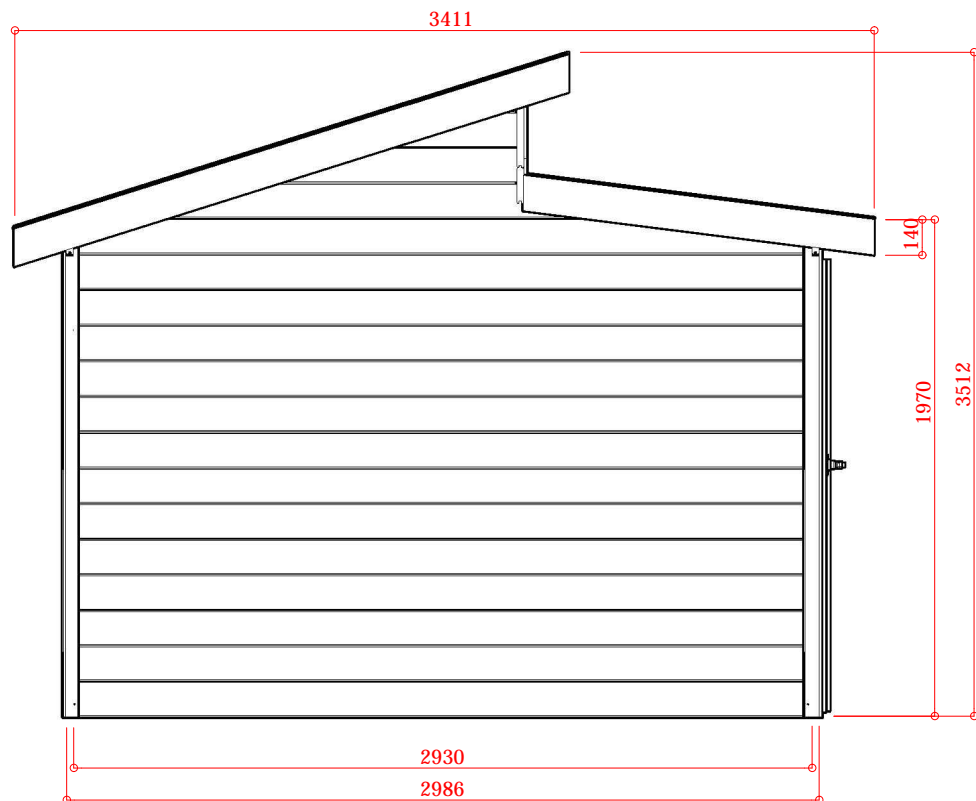

# S8246

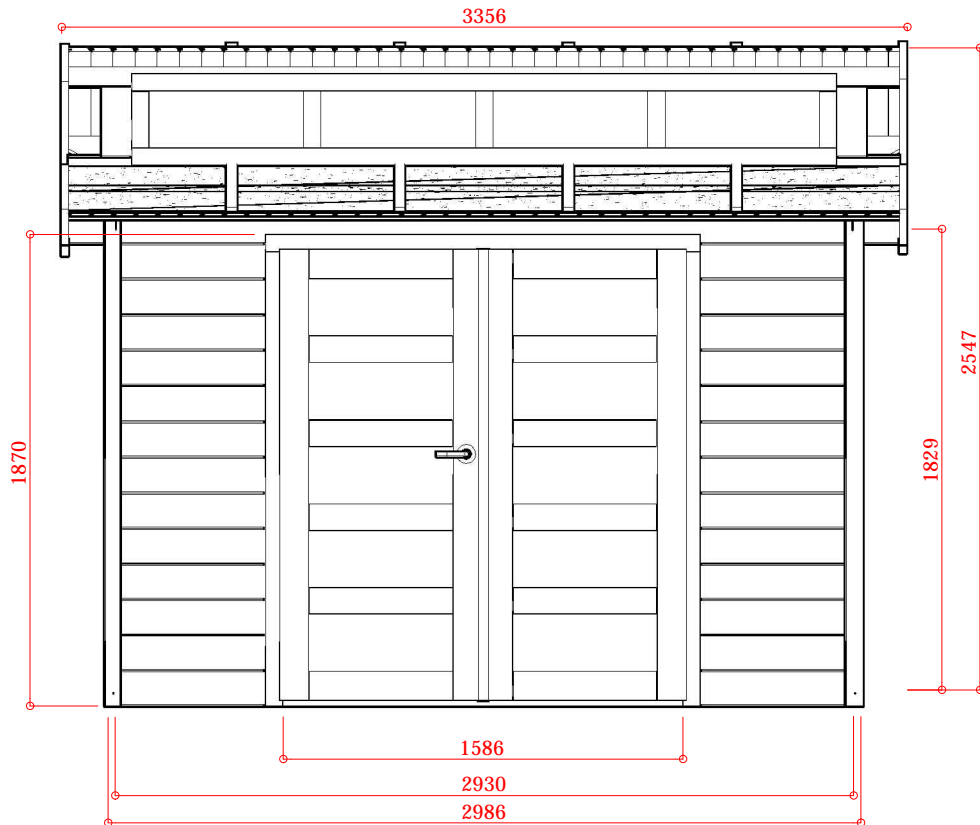

	<b>8,58</b> m <sup>2</sup>
	<b>11,45</b> m <sup>2</sup>

Schaal / Échelle / Scale / Escala / Escala / Scala : 1:30

Dakhelling ± 3 °	Pendente ± 3 °
Pente ± 3 °	Pendiente ± 3 °
Gradient ± 3 °	Pendenza ± 3 °



Industriepark 8  
8587 Spiere-Helkijn

CreateDate: 18.12.2014  
SaveDate: 20.12.2014  
PlotDate: 20.12.2014

Deuropening / Embrasure de porte / Doorway / Apertura de puerta / Apertura delle porte / Abertura de portas	
Breedte / Largeur / Width / Anchura / Boca / Larghezza	1586
Hoogte / Hauteur / Height / Altura / Altezza / Altura	1770

# S8246

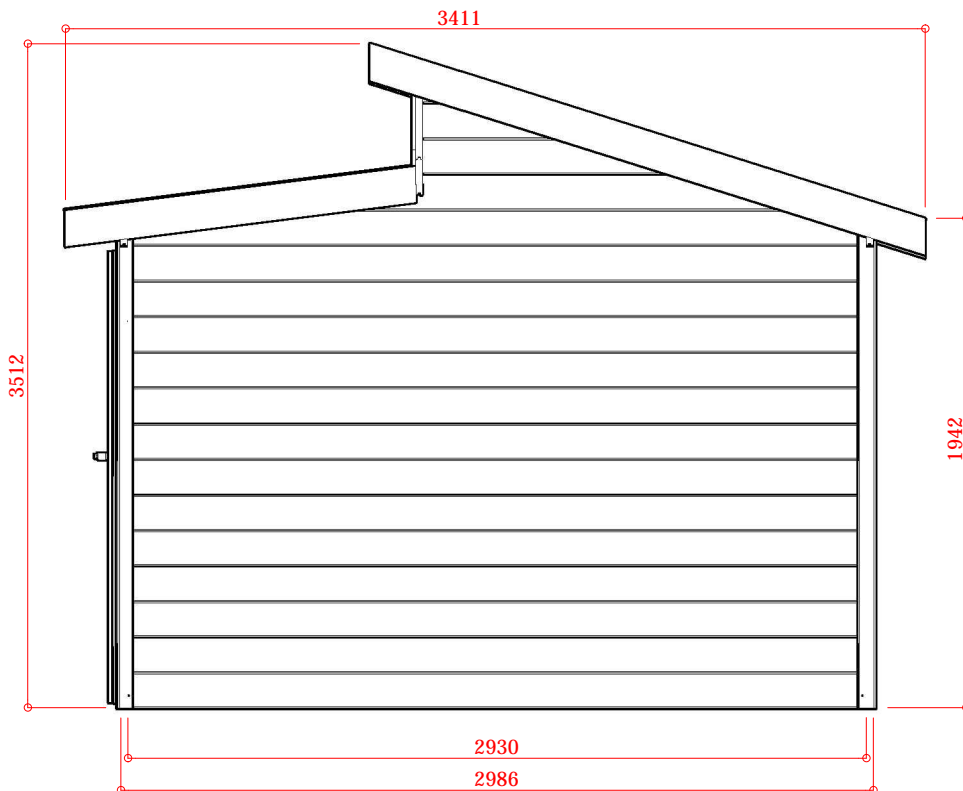
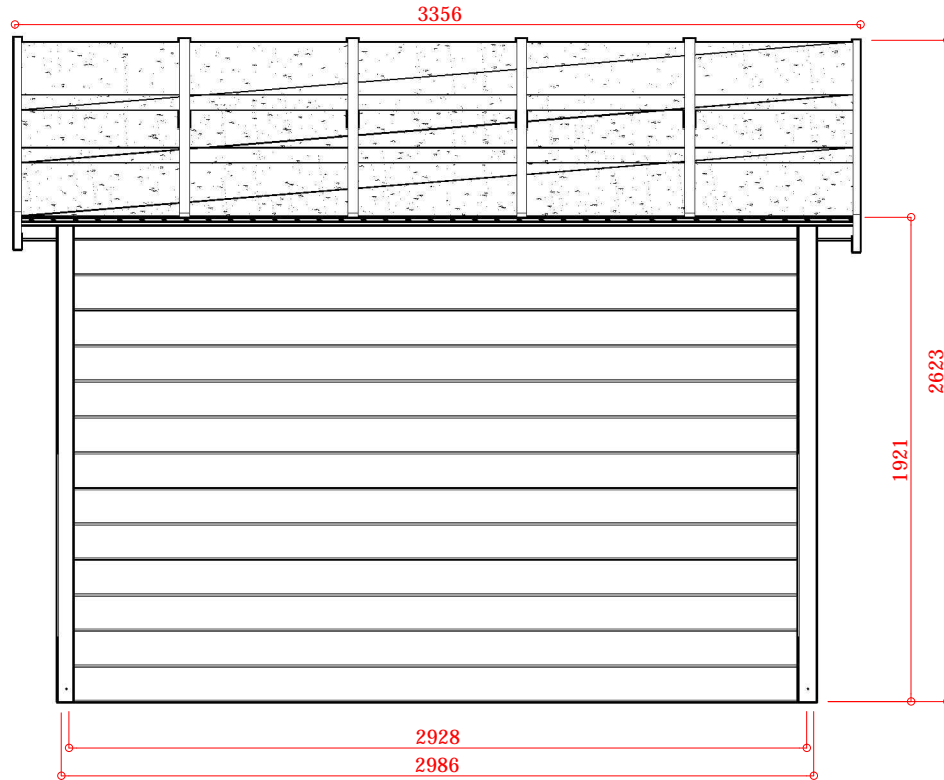

Industriepark 8  
8587 Spiere-Helkijn

CreateDate: 18.12.2014  
SaveDate: 20.12.2014  
PlotDate: 20.12.2014

Schaal / Échelle / Scale / Escala / Escala / Scala : 1:30

	Ref.		Index	#
	A	WW028x141/700	2980	1
	A1	WW028x141/700	2980	1
	B	WW028x149	645	13
	C	WW028x149	645	13
	E	WW028x149	2960	26
	F	WW028x141	3300	1
	F1	WW028x141	3300	1
	F2	WW028x141	3300	1
	G	WW028x149	2960	13
	H	WW028x145	300	1
	H1	WW028x145	300	1
	J	WW019x95	1400	38
	J1	WW019x95	2300	38
	K	WW040x95	3300	1
	K1	WW028x68	3300	1
	L	WW016x40	1400	4
	L1	WW016x40	2300	4
	L2	WW016x40	3300	2
	M	WW028x145	1270	2
	M1	WW028x145	2300	2
		<b>S8038</b> + 2 x P1 (56 x 70 x 1830) + 1 x P2 (56 x 70 x 1830) + 1 x P3 (16 x 40 x 1785) + 1 x ALU 20x60x786 + GLASS 249x596		
		<b>S----</b> + GLASS 249x637		

## S8246









## PO \_\_\_\_\_

Winkel / Magasin / Store / :

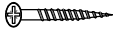
Klant / Cliënt / Client / :  
Adres:

Verantwoordelijke / Responsable

fl

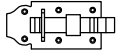
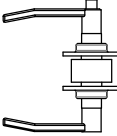
		Ref.	L	Index	#
S691-L		V	80 x 72 x 1950		2
S691-R		V1	80 x 72 x 1950		2
S665-V			3.0 x 30 (52) 3.0 x 40 (4) 3.0 x 50 (28) 3.0 x 70 (4) 4.0 x 70 (2) 2.4 x 40 (260) 3.0 x 16 (200) M6 x 40 (16) M6 (16)		
					
					
					
					
S504		O	Roofing 7.2 m		1
S505		O1	Roofing 10.7 m		1
					2
S80201					1

**S8246**

**PO** \_\_\_\_\_

Winkel / Magasin / Store / :

Klant / Cliënt / Client / :  
Adres:

Verantwoordelijke / Responsable

fl

**S8246**

# YOU CAN ARRANGE!

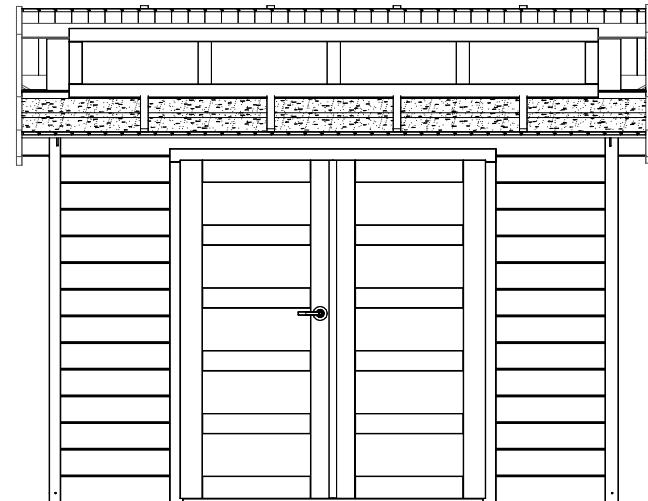
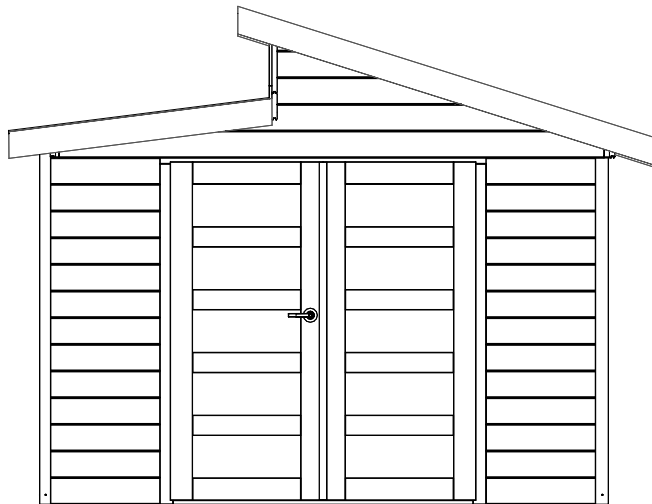
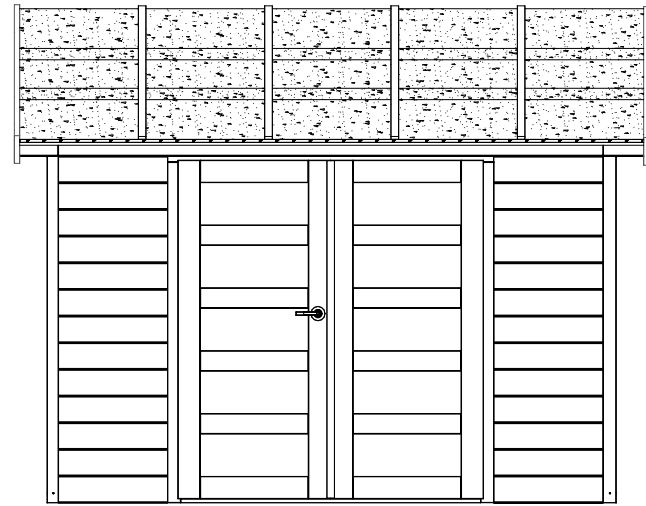
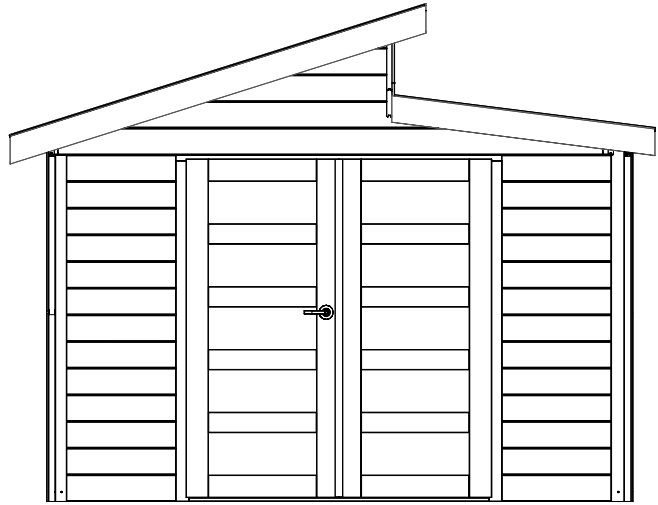

# S8246

E = 2  
G = 1  
B = 1  
C = 1  
V = 2  
V1 = 2

1

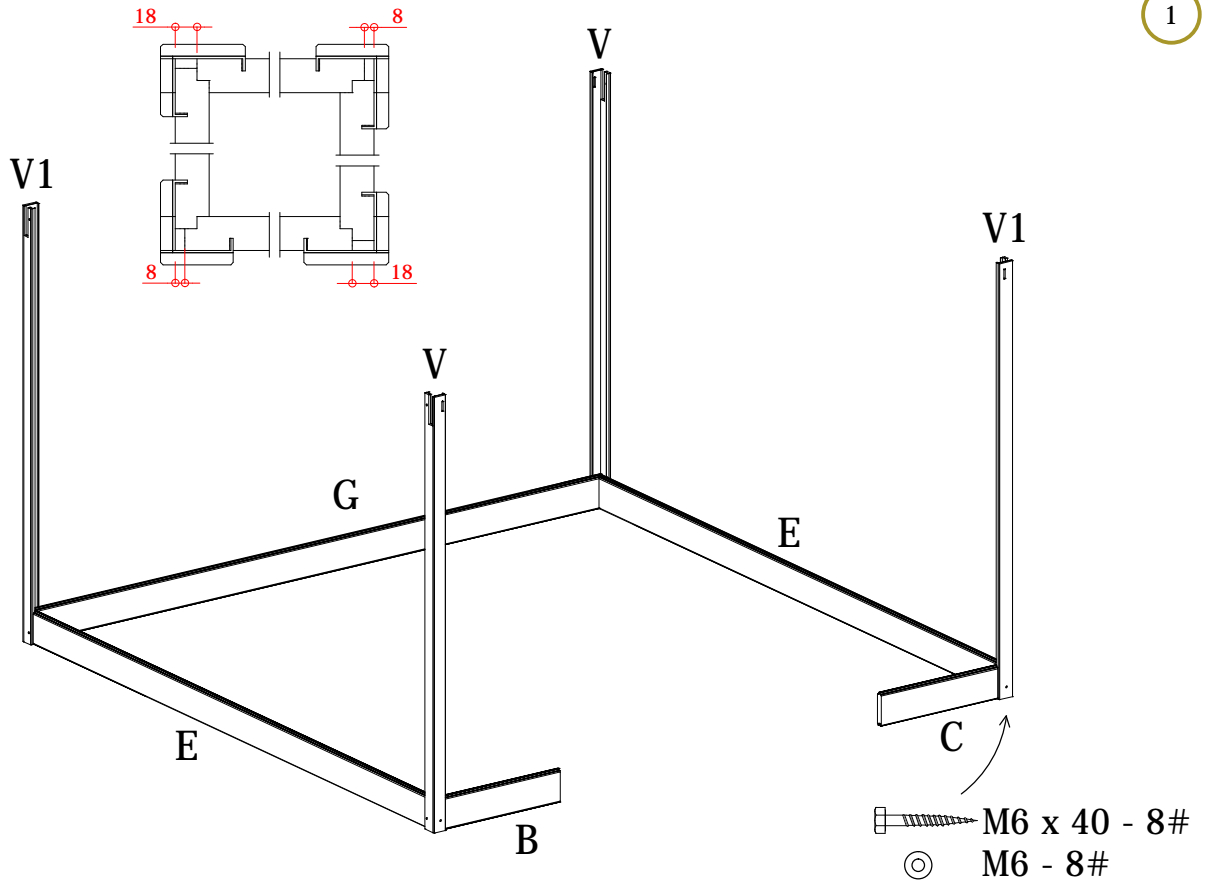

B = 12  
C = 12  
E = 24  
G = 12

2

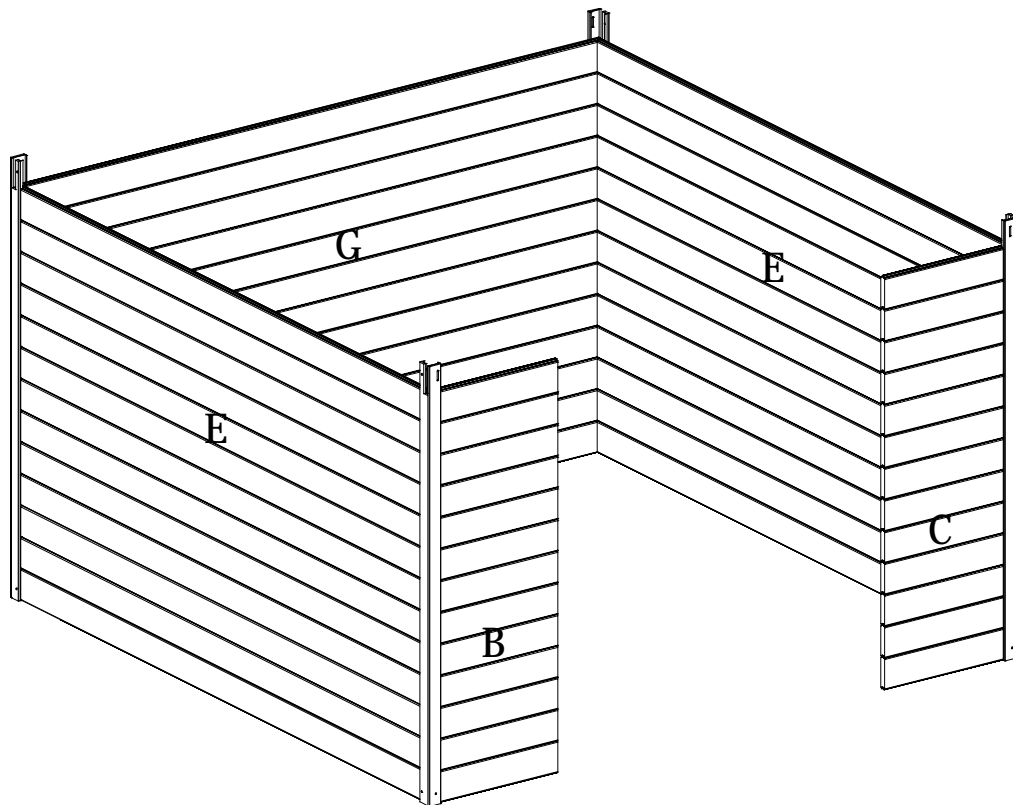

# S8246

P1 = 2  
P2 = 1

3

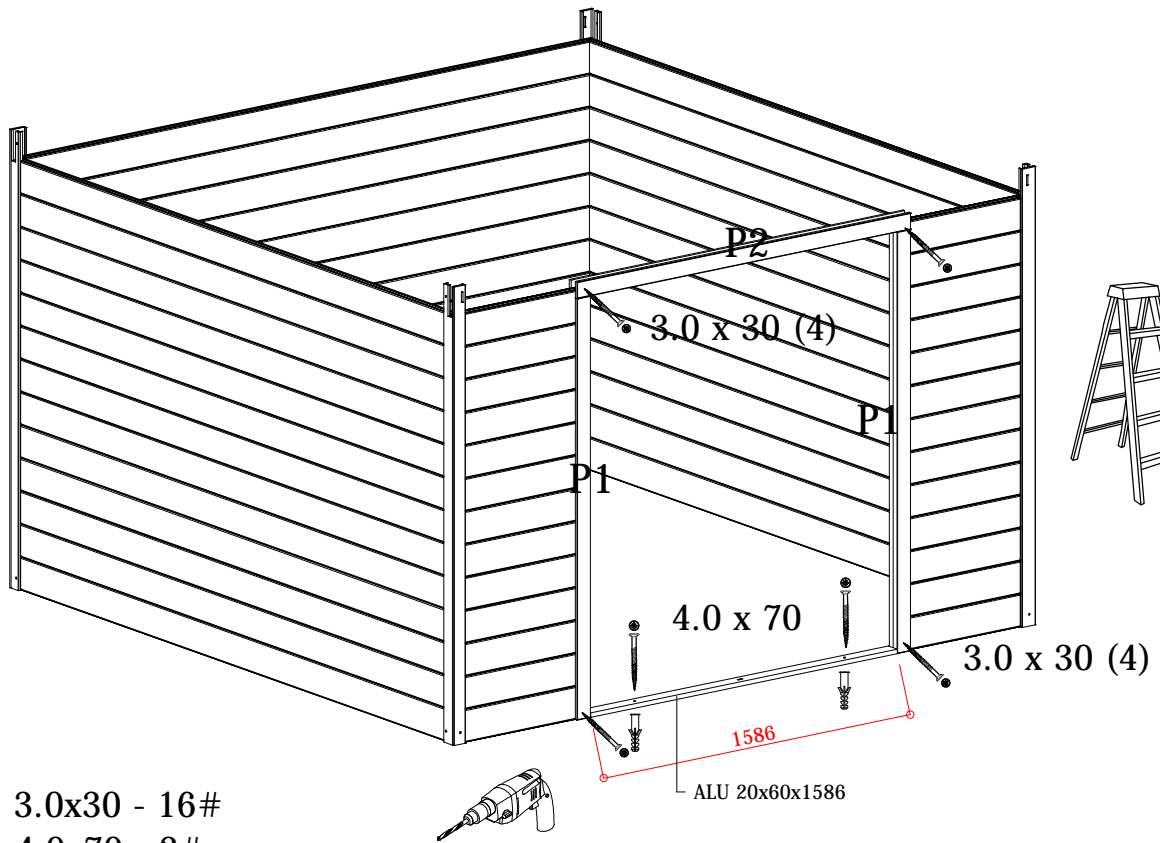

 2#

 3.0x30 - 16#

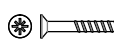
 4.0x70 - 2#



ALU 20x60x1586

A = 1  
A1 = 1  
F = 1  
F1 = 1  
F2 = 1

4

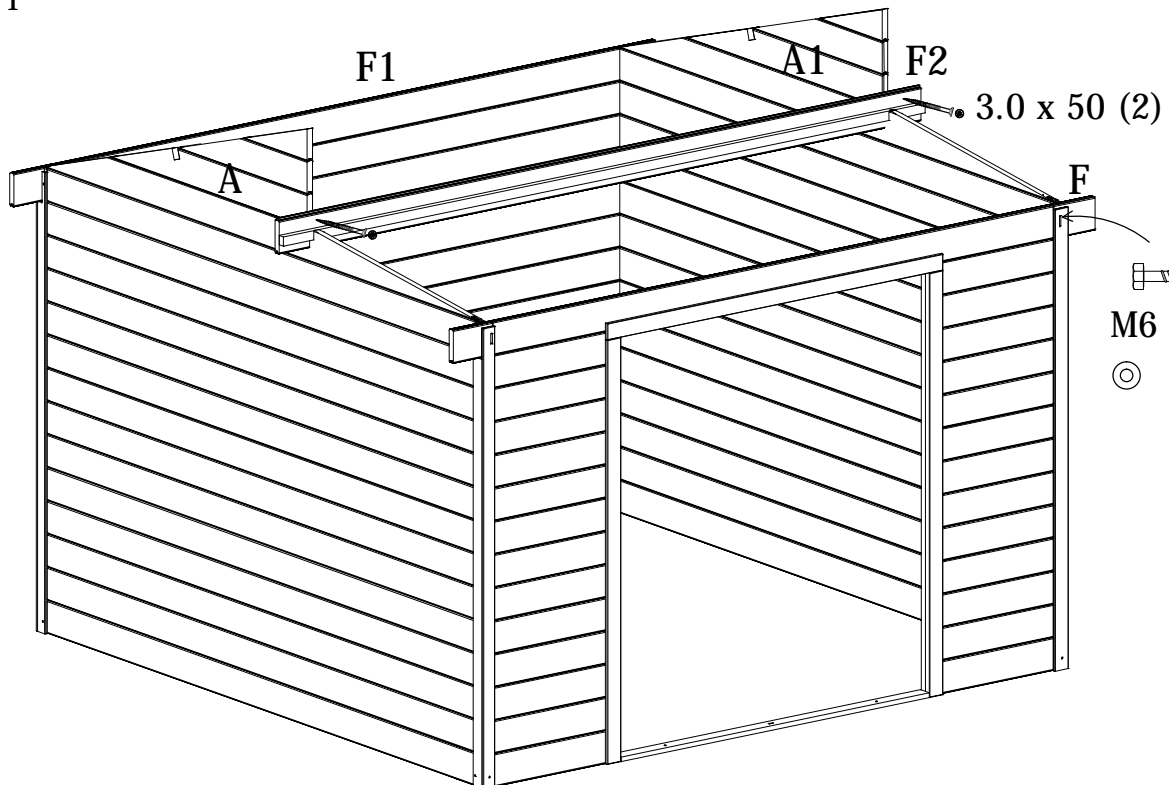

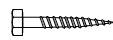
 M6 x 40 - 8#

 M6 - 8#

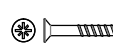
 3.0x50 - 4#

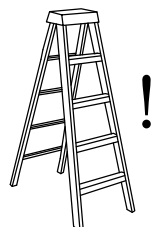
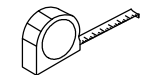



# S8246

5

J = 38

K = 1

 2,5X40#100

 3.0x70 - 4#

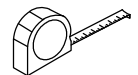
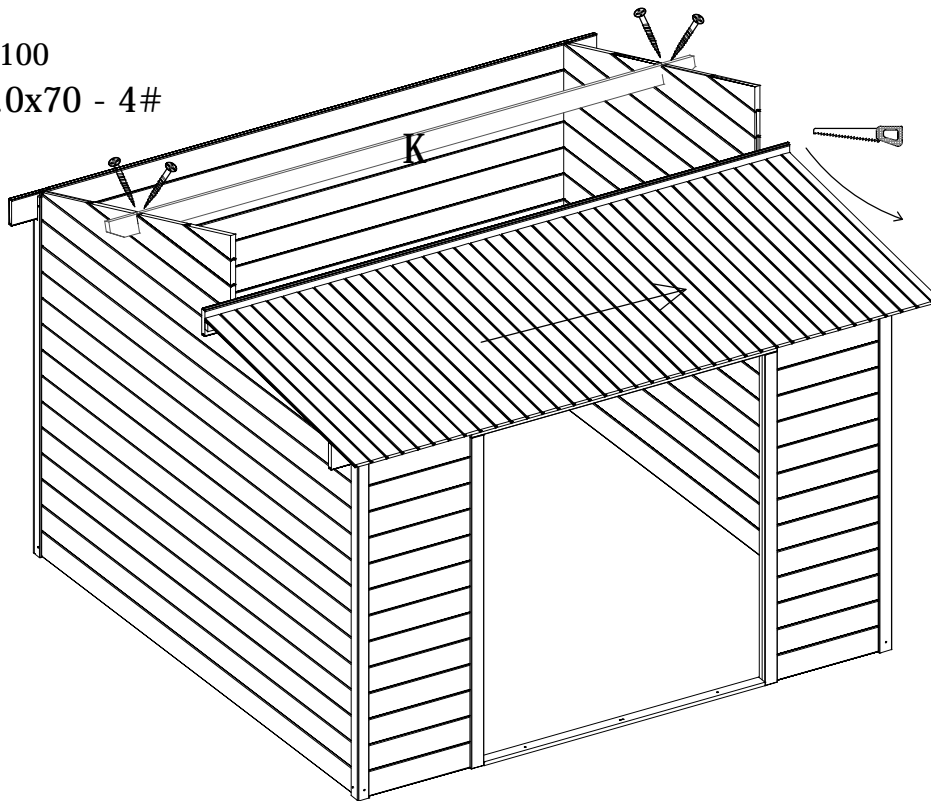

6

O = 2x3380

 3.0 x 16 - 80#

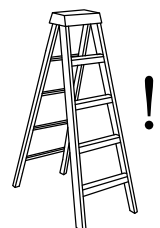
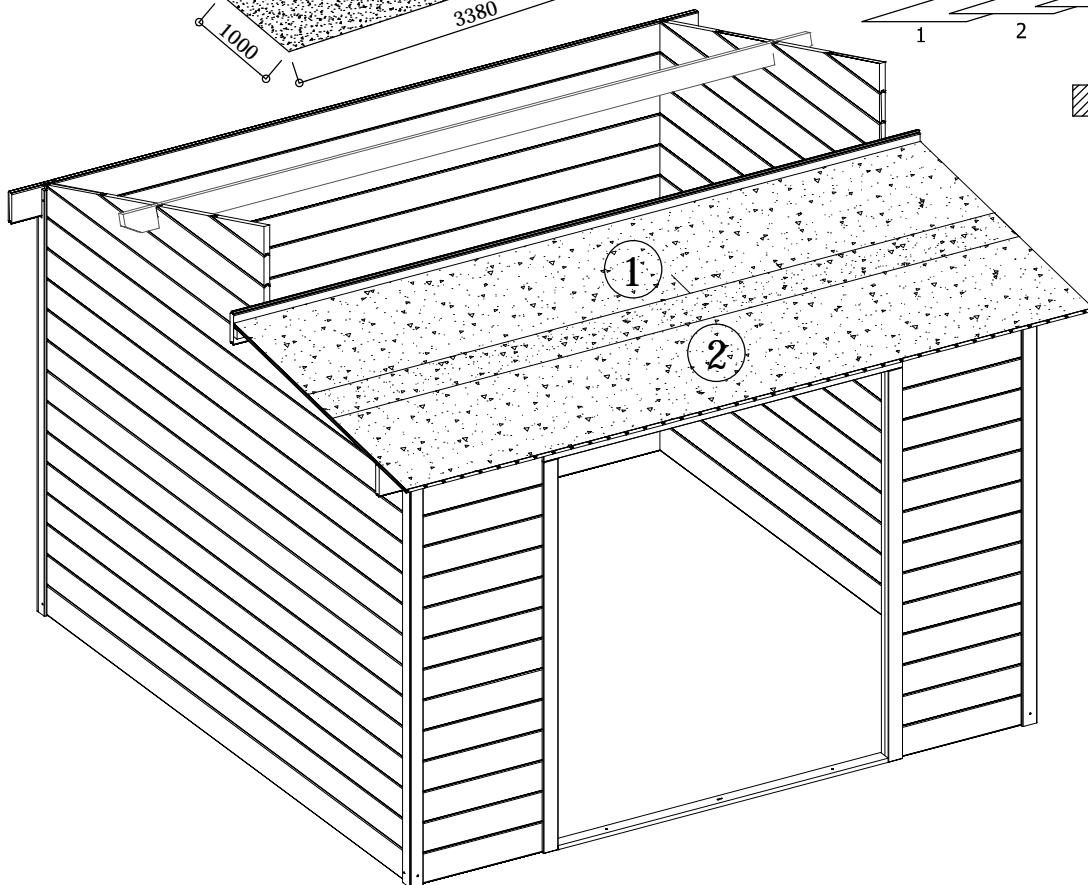
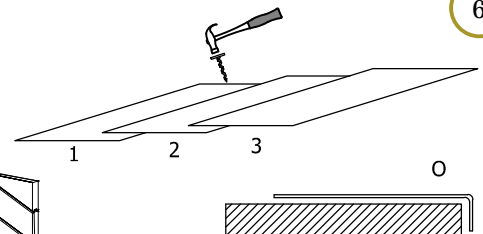
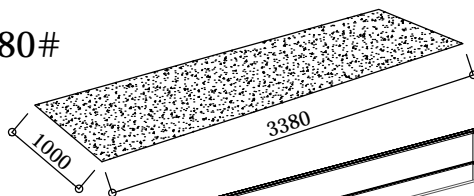



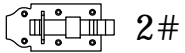
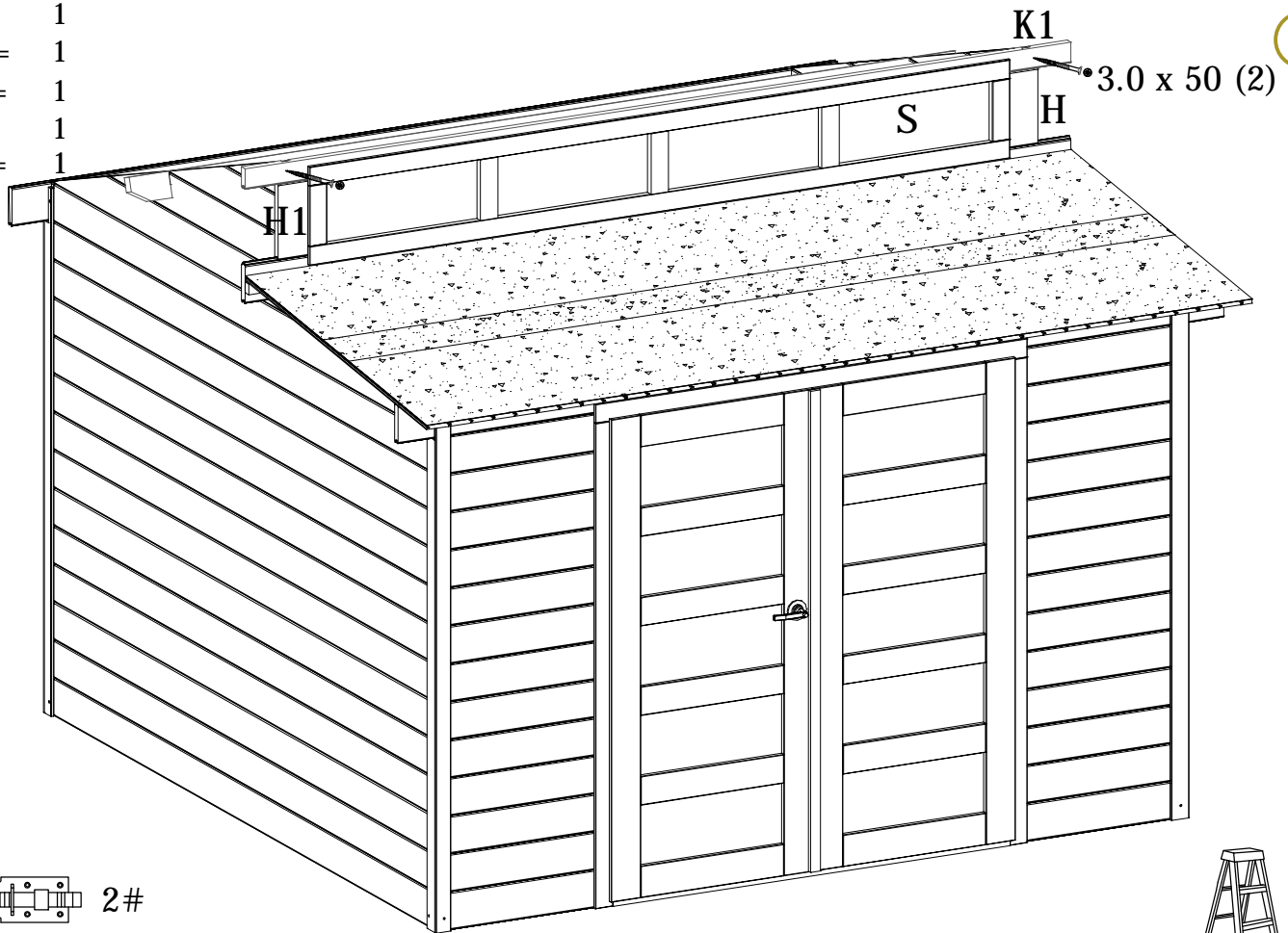

# S8246

H = 1  
H1 = 1  
K1 = 1  
S = 1  
P3 = 1



-  3.0x30 - 12#
-  3.0x40 - 4#
-  3.0x50 - 4#

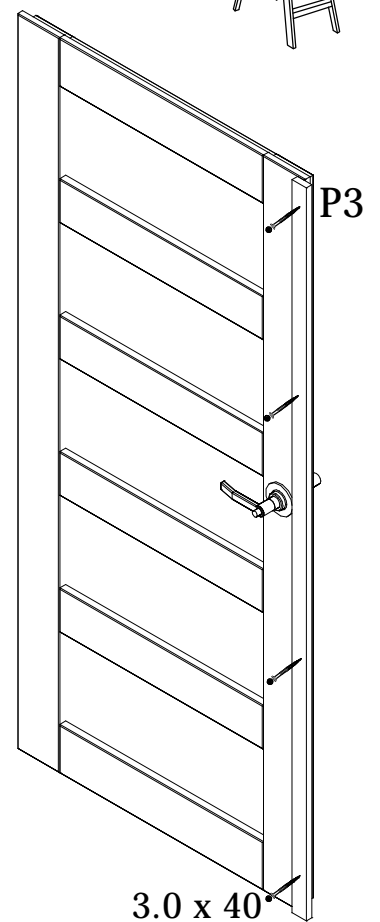
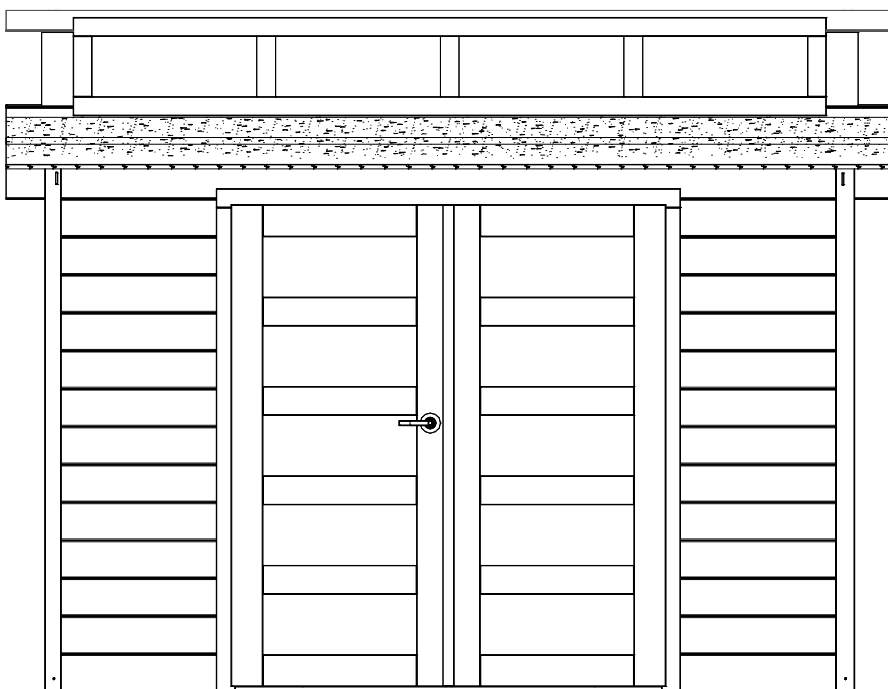

# S8246

J1 = 38

 2,5X40#140

8

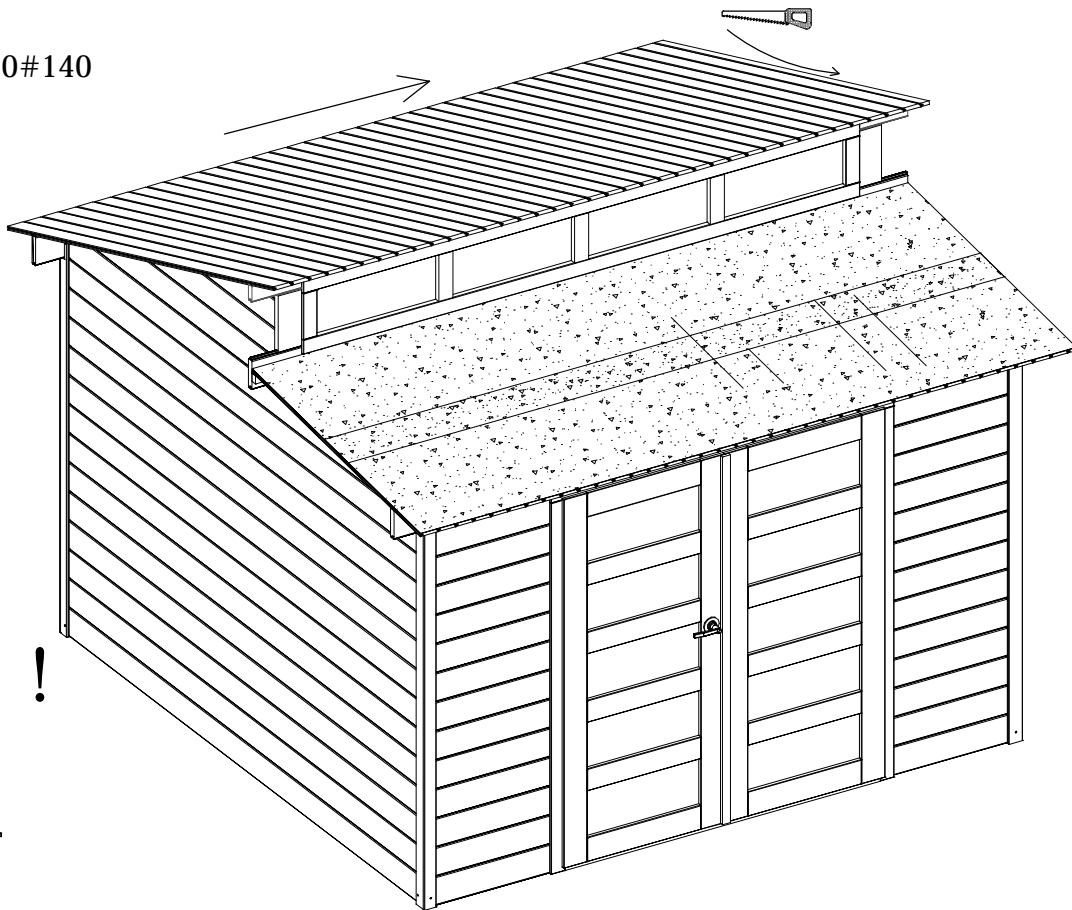
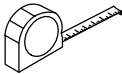
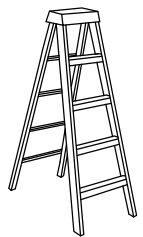

O1= 3x3380

 3.0 x 16 - 120#

9

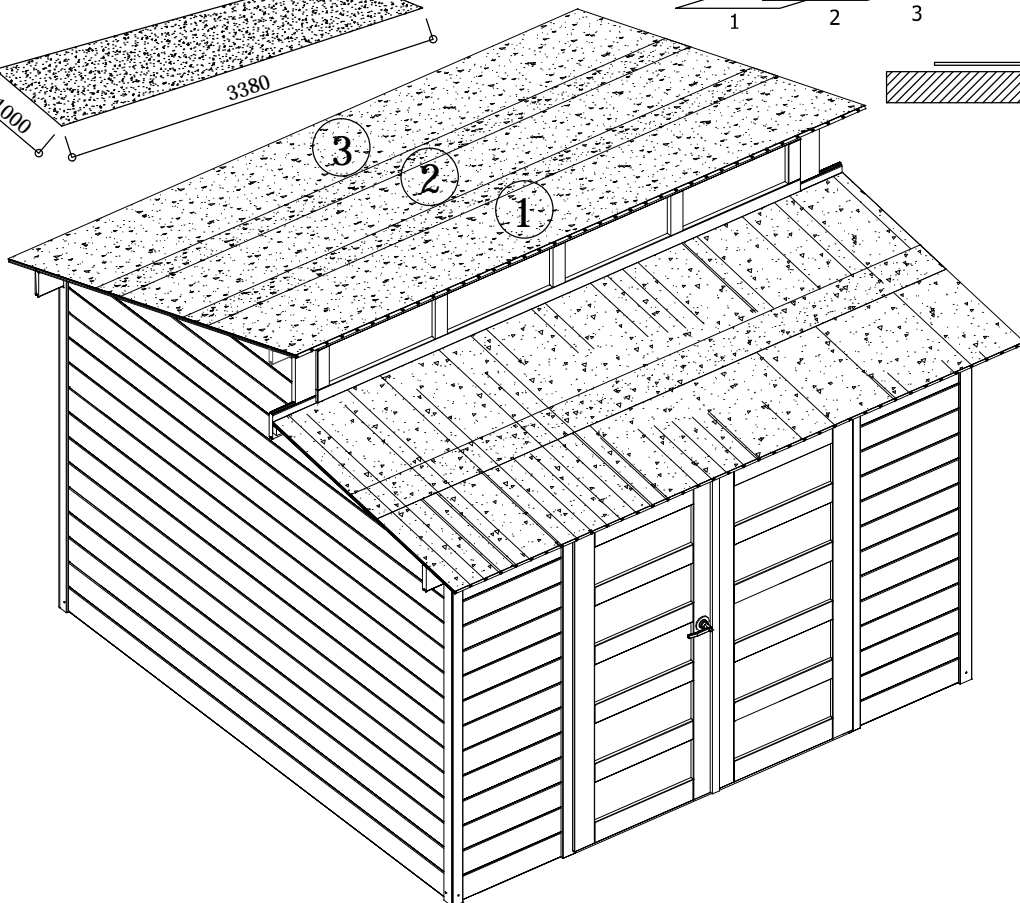
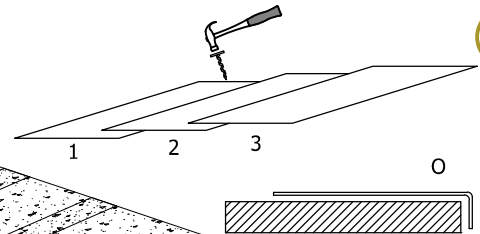
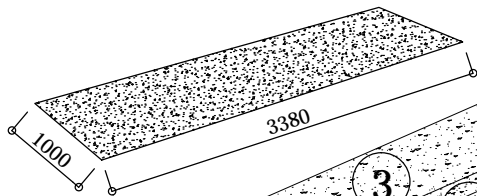

# S8246

M = 2

M1 = 2

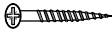
 3.0 x 50 - 20#

10

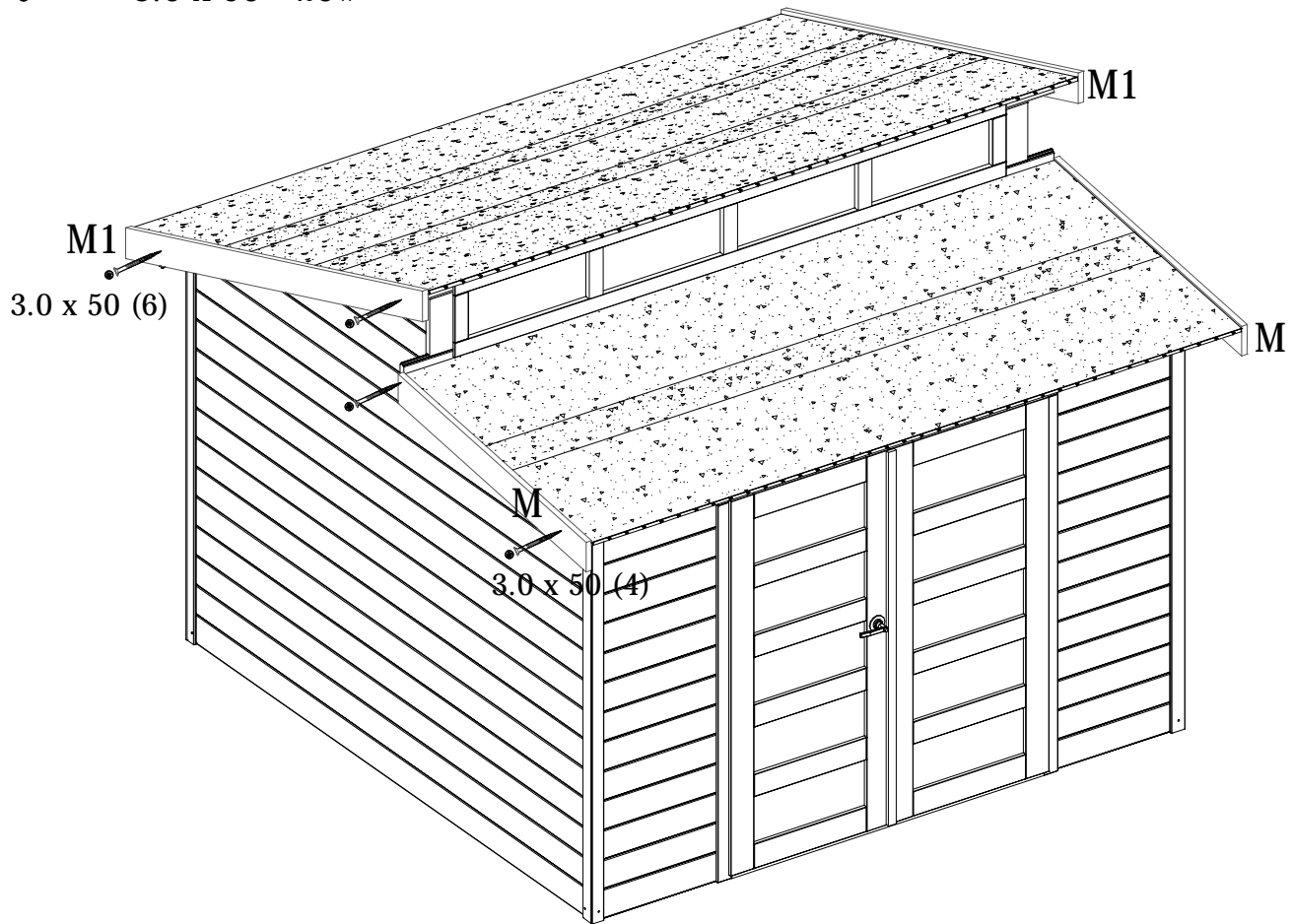

L = 4

L1 = 4

L2 = 2

 2,5X40#20

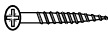
 3.0 x 30 - 24#

11

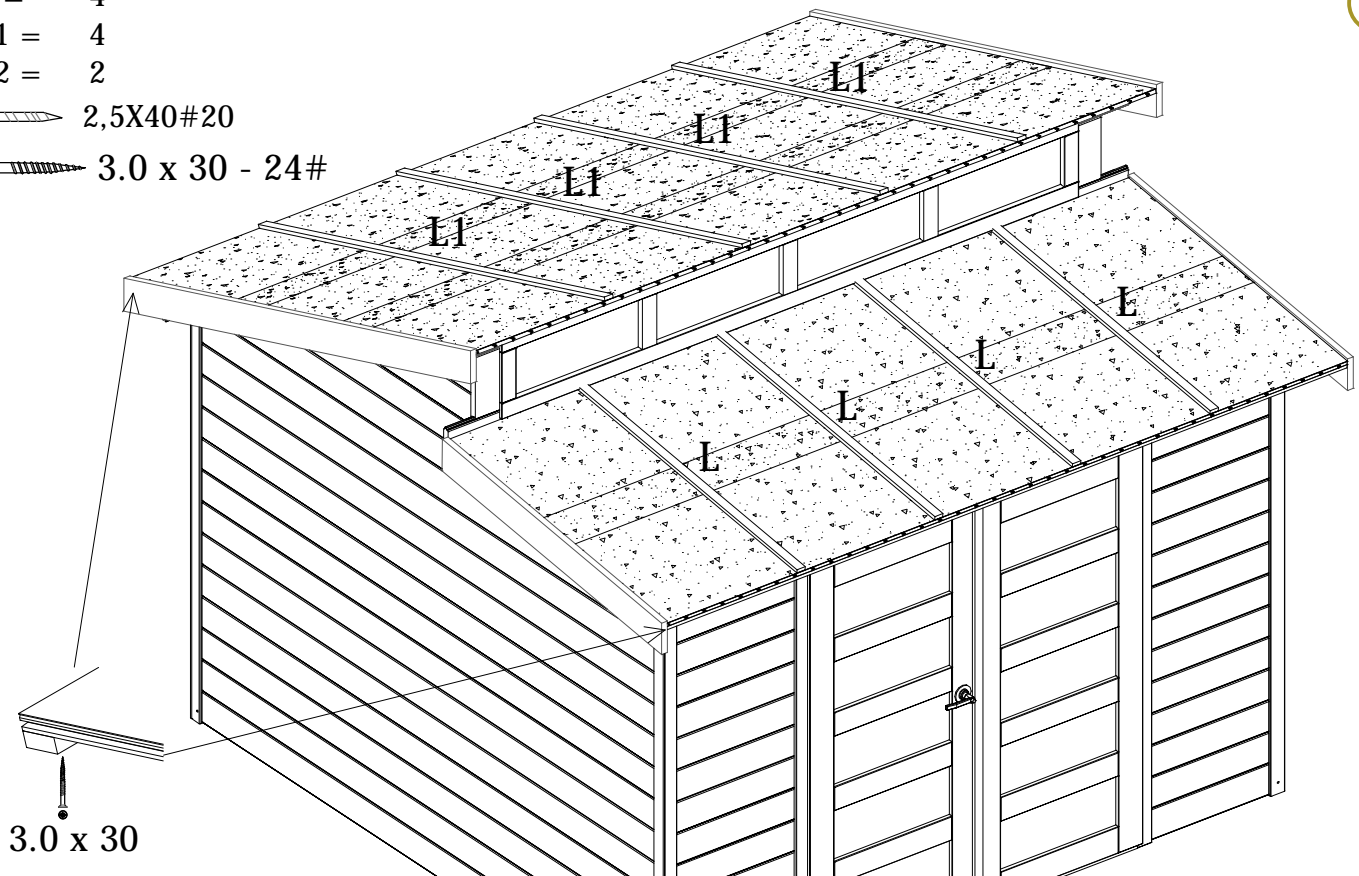

S8246

