

# ABRI DE JARDIN METAL

## NOTICE DE MONTAGE

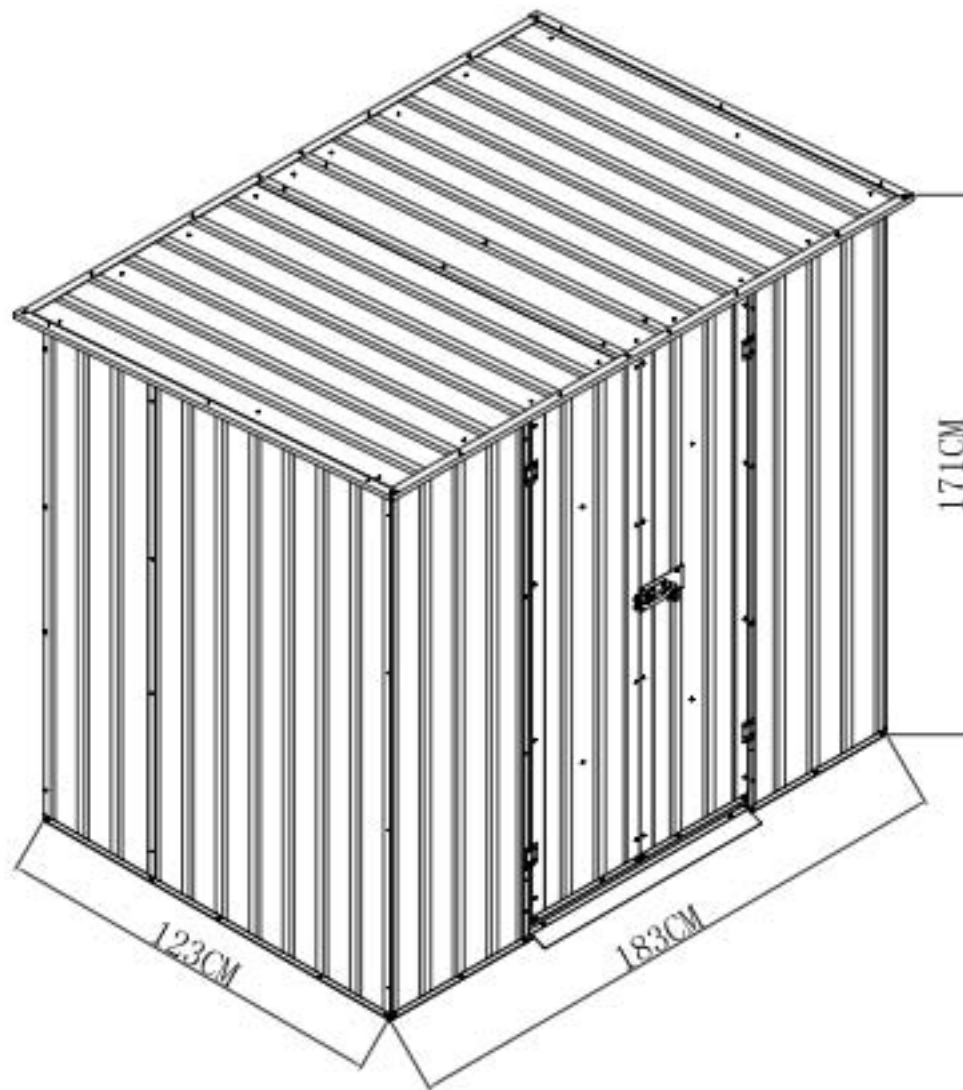







### Référence : AM 1812





Dimensions : largeur 1.83 m x profondeur 1.23 m x hauteur 1.71 m





En raison d'amélioration continue, le produit que vous recevrez peut différer légèrement du produit décrit.





Lire attentivement le manuel d'instructions avant le montage et l'utilisation de l'abri.





# LISTE DES PIÈCES DETACHEES













Pièces détachées cadre avant		
dessin	N° pièce	Nombre
	F1	1
	F2	2
	F3	1
	F4	2
	F5	1
	F6	1
	F10	1









Pièces détachées coté gauche		
dessin	N° pièce	Nombre
	L1	1
	L2	1
	L3	1
	L4	1

Pièces détachées coté droit		
dessin	N° pièce	Nombre
	R1	1
	R2	1
	R3	1
	R4	1

Pièces détachées cadre arrière		
dessin	N° pièce	Nombre
	B1	2
	B2	1
	B3	1
	B4	1

Pièces détachées toit		
dessin	N° pièce	Nombre
	T1	2
	T2	1
	T3	2
	T4	2

Pièces détachées porte		
dessin	N° pièce	Nombre
	DL1	1
	DL2	1
	DL3	1
	DL4	1
	DL5	1
	DL6	2
	DR1	1
	DR2	1
	DR3	1
	DR4	1
	DR5	1
	DR6	2

Accessoires		
dessin	N° pièce	Nombre
	W1	4
	W2-1	1
	W2-2	1
	W3	210
	W5	8
	W6	8
	W7	1
	W8	80

1.

Faites glisser les panneaux dans les glissières basses et hautes.

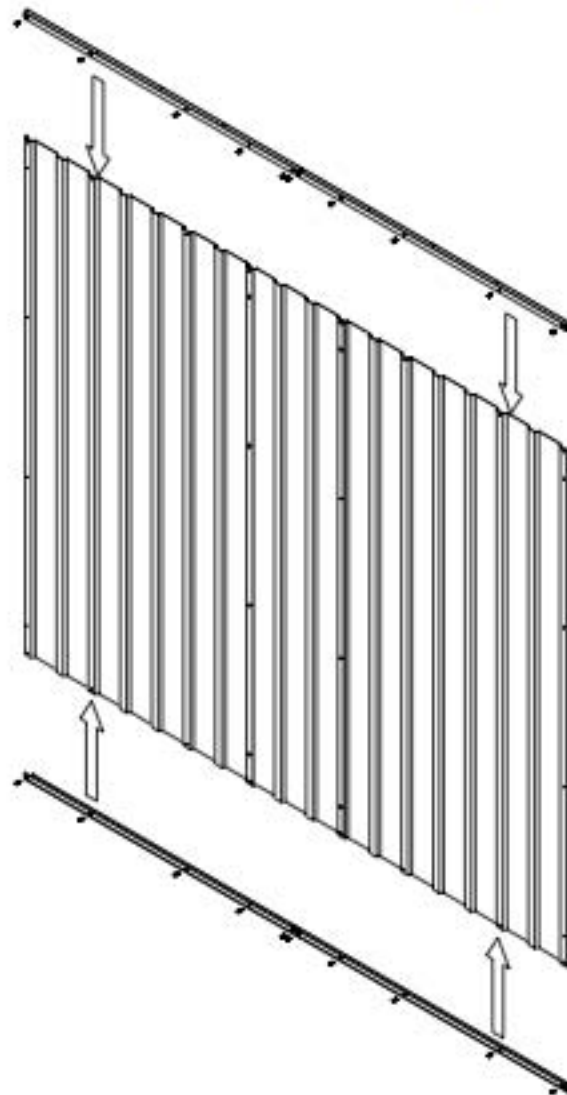
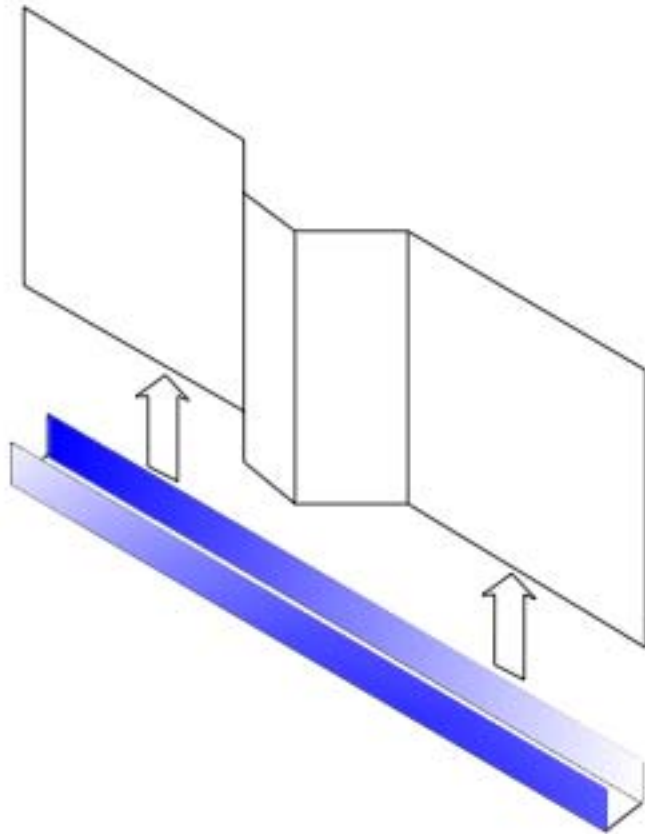

#### 4. Assemblage coté droit

Assemblez les parties murales R3 et R4 avec les vis;  
les fixer aux glissières R1 et R2 au moyen des vis

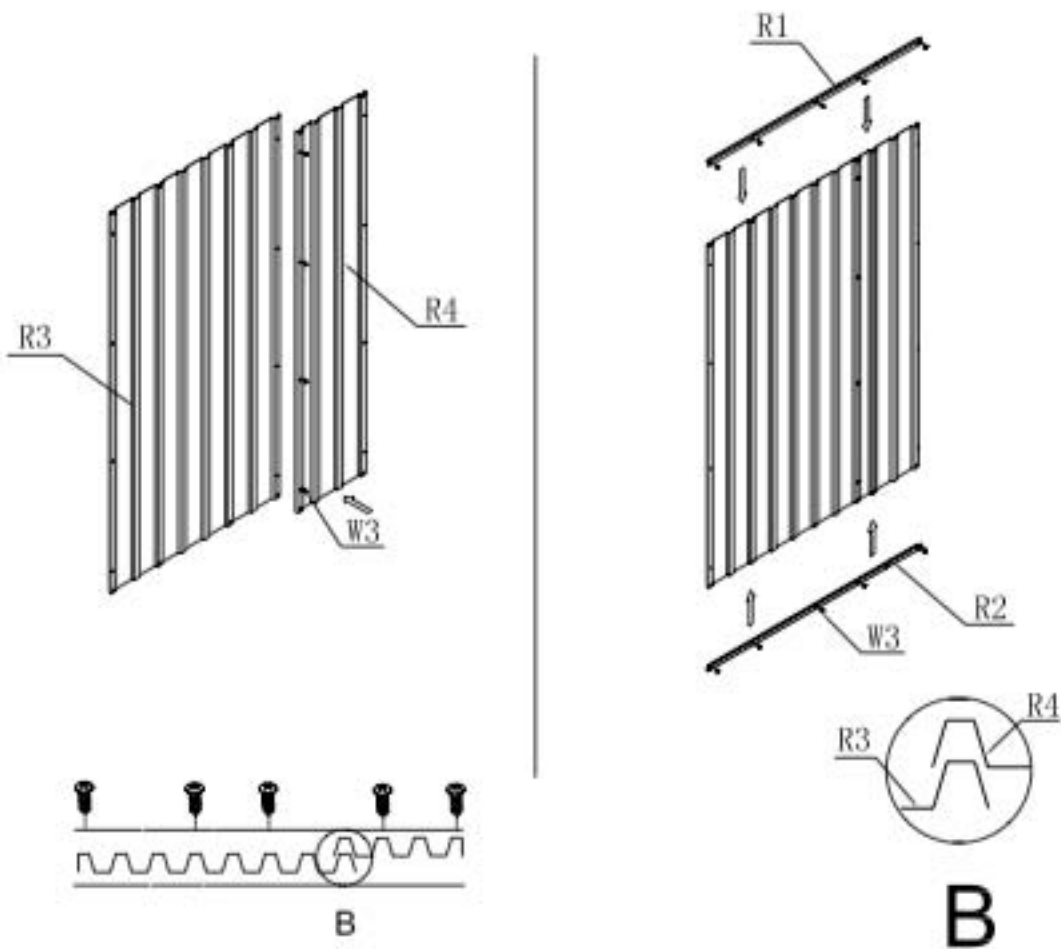

NOMBRE : 1

dessin	N° pièce	Nombre
	R1	1
	R2	1
	R3	1
	R4	1
	W3	14

#### 5. Assemblage de l'arrière

Assemblez les parties murales B1 et B2 avec les vis.  
Ensuite montez les glissières B3 et B4 avec les vis.

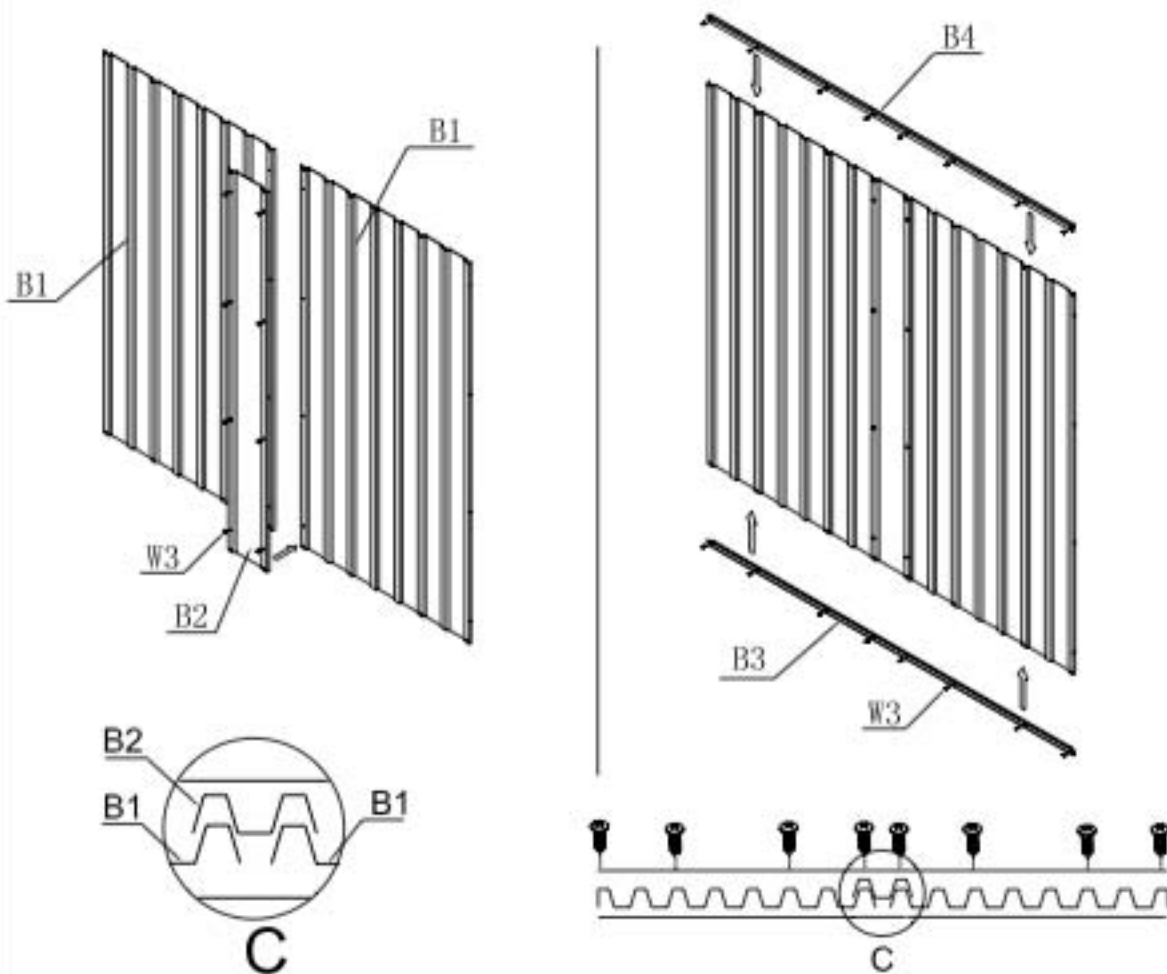

NOMBRE : 1

dessin	N° pièce	Nombre
	B1	2
	B2	1
	B3	1
	B4	1
	W3	24

## 6. Assemblage du toit

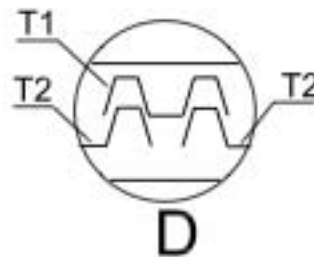
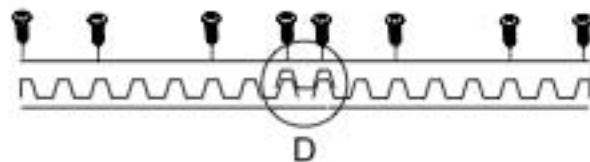
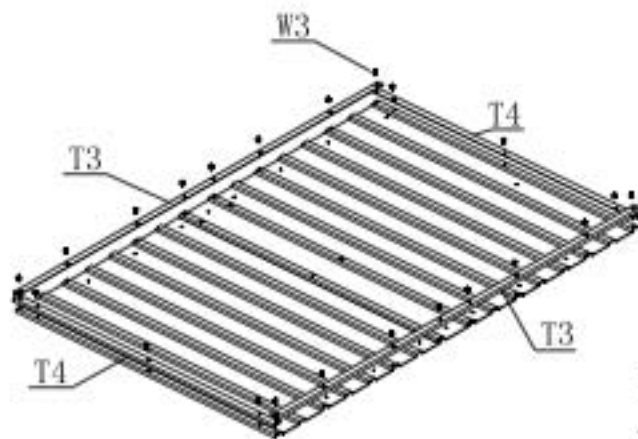
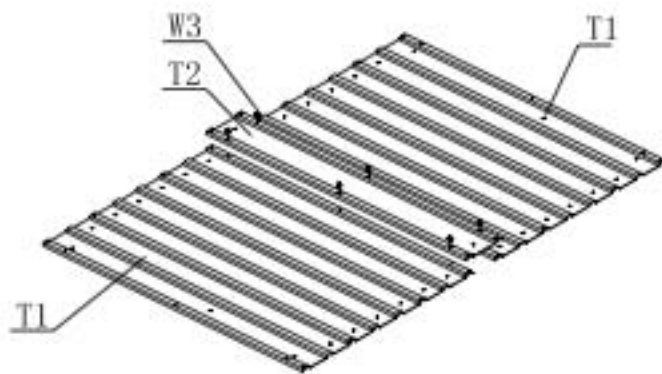

NOMBRE : 1

dessin	N° pièce	Nombre
	T1	2
	T2	1
	T3	2
	T4	2
	W3	28

7. Lorsque vous assemblez les cadres avant, arrière, gauche et droit, assurez-vous que les trous les plus larges soient à l'extérieur et les plus petits à l'intérieur.

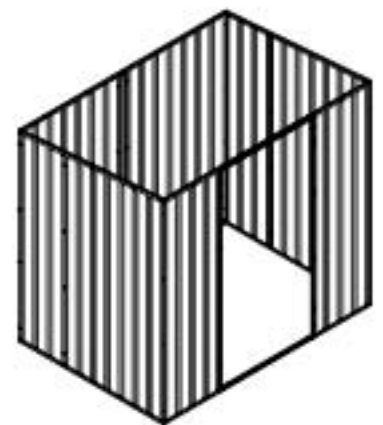
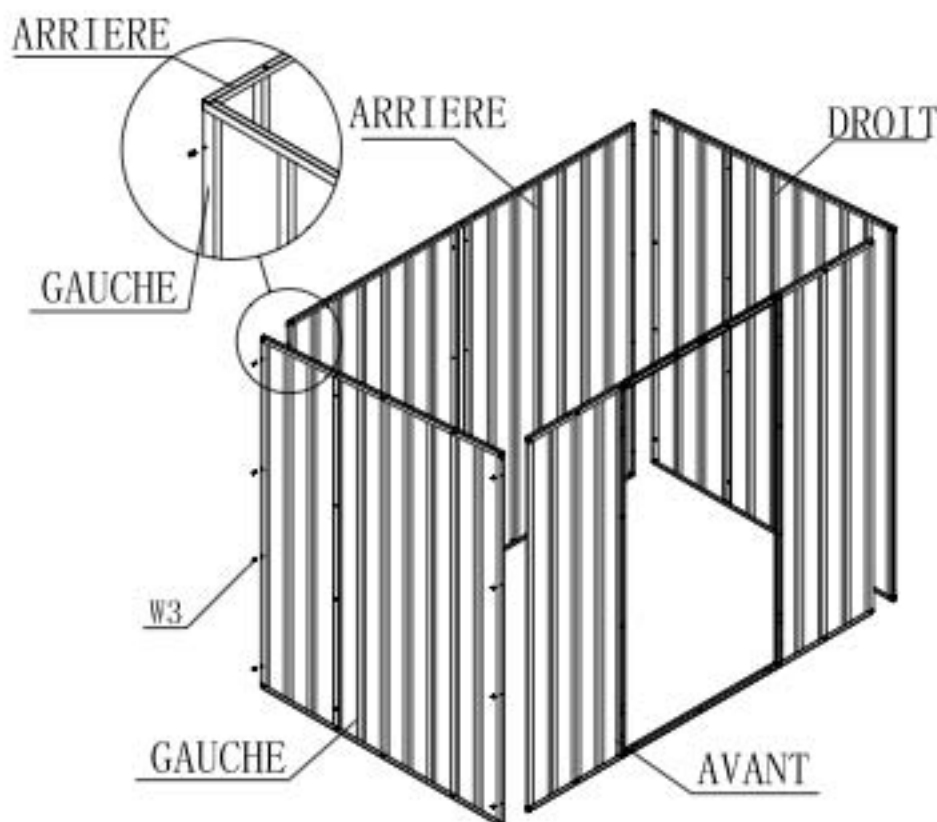



NOMBRE : 1

dessin	N° pièce	Nombre
	FRONT	1
	LEFT	1
	RIGHT	1
	BACK	1
	W3	16

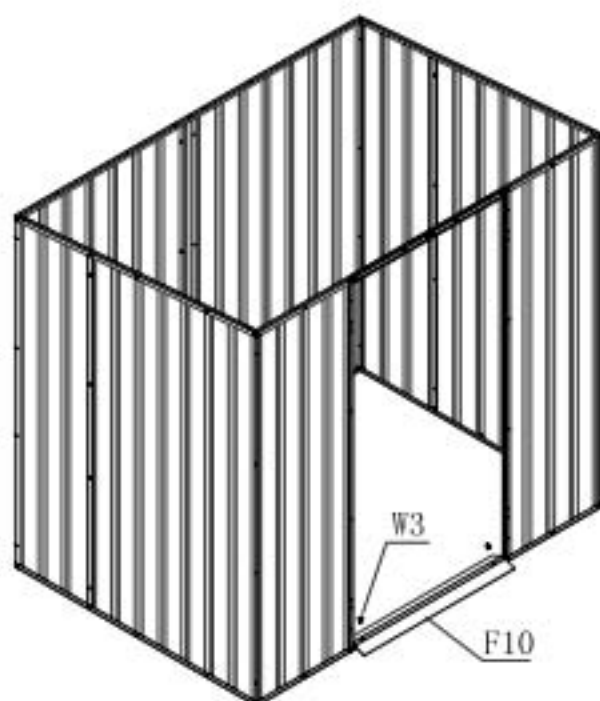

8. Fixer la pièce F10.

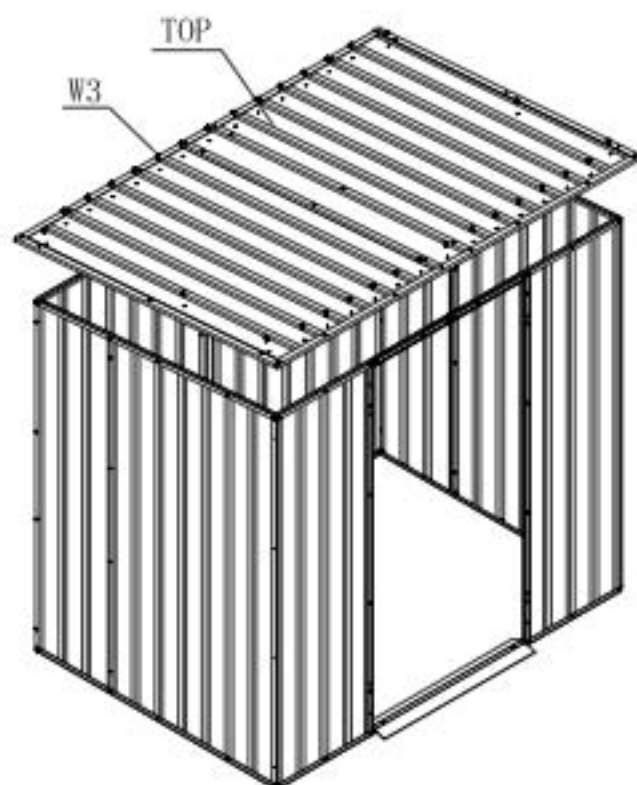

dessin	N° pièce	Nombre
	F10	1
	W3	2

9. Placer le toit et le fixer au moyen des vis dans les emplacements pré-marqués.



dessin	N° pièce	Nombre
	TOP	1
	W3	32

### 10. Assemblage de la porte gauche

Fixer les cadres DL3 et DL5 puis DL1 et DL4 sur la tôle de la porte

Fixer les charnières sur le cadre

Fixer les 2 barres de renfort à l'intérieur de la porte

Fixer le crochet de fermeture

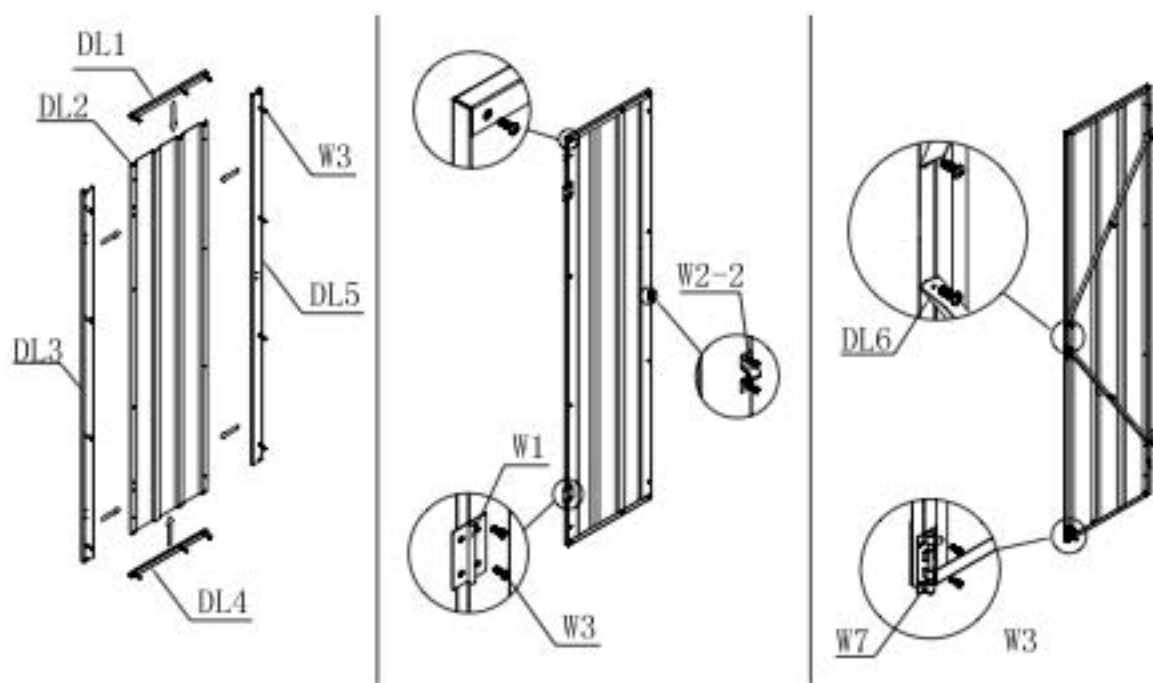

dessin	N° pièce	Nombre
	DL1	1
	DL2	1
	DL3	1
	DL4	1
	DL5	1
	DL6	2
	W1	2
	W7	1
	W3	26

### 11. Assemblage de la porte droite

Fixer les cadres DR3 et DR5 puis DR1 et DR4 sur la tôle de la porte

Fixer les charnières sur le cadre

Fixer les 2 barres de renfort à l'intérieur de la porte

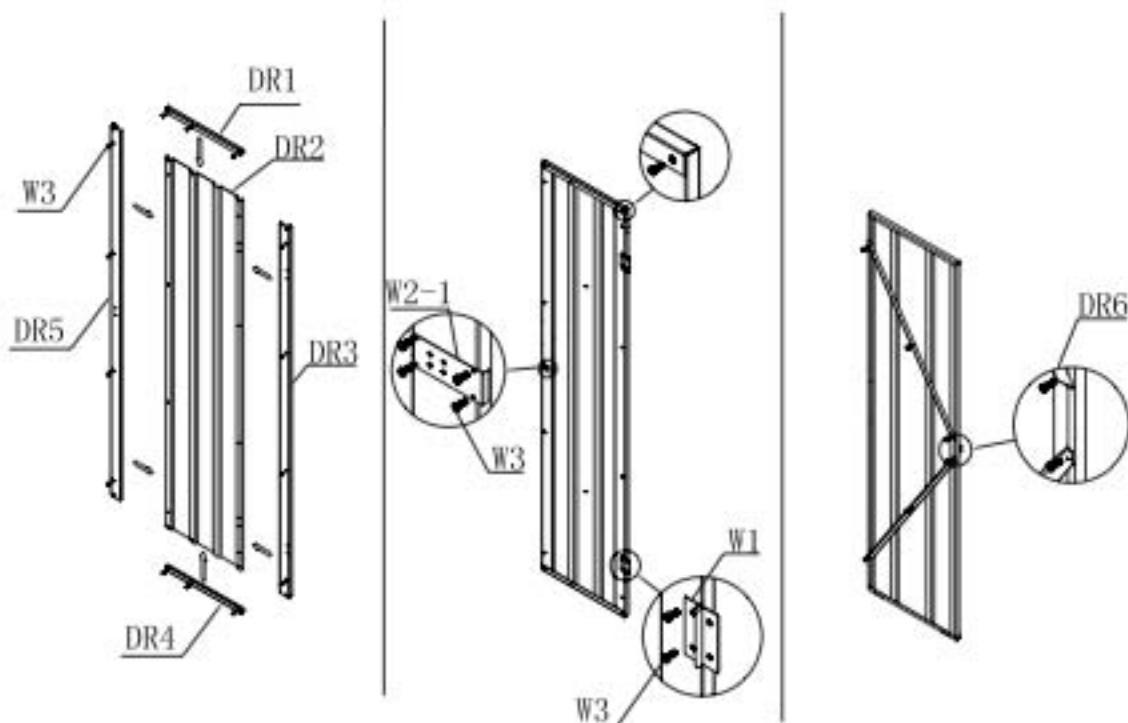

Fixer le crochet de fermeture



dessin	N° pièce	Nombre
	DR1	1
	DR2	1
	DR3	1
	DR4	1
	DR5	1
	DR6	2
	W1	2
	W2-1	1
	W3	26

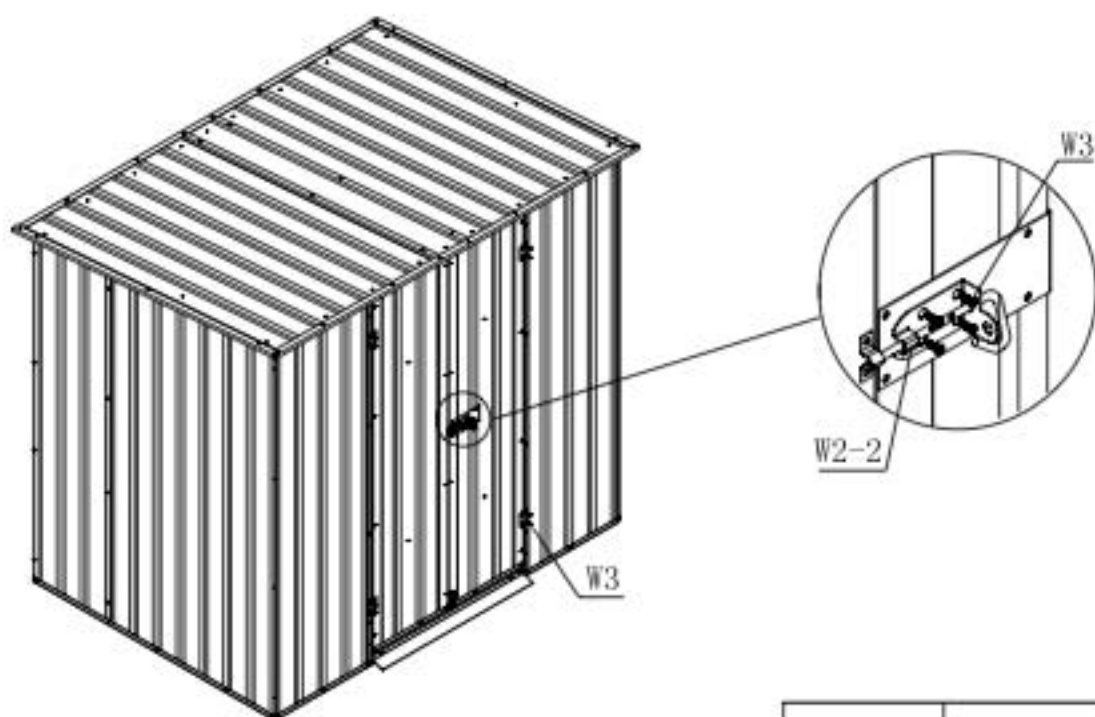

12. assembler les pièces W2-2 et W3 et les fixer à la pièce F2.

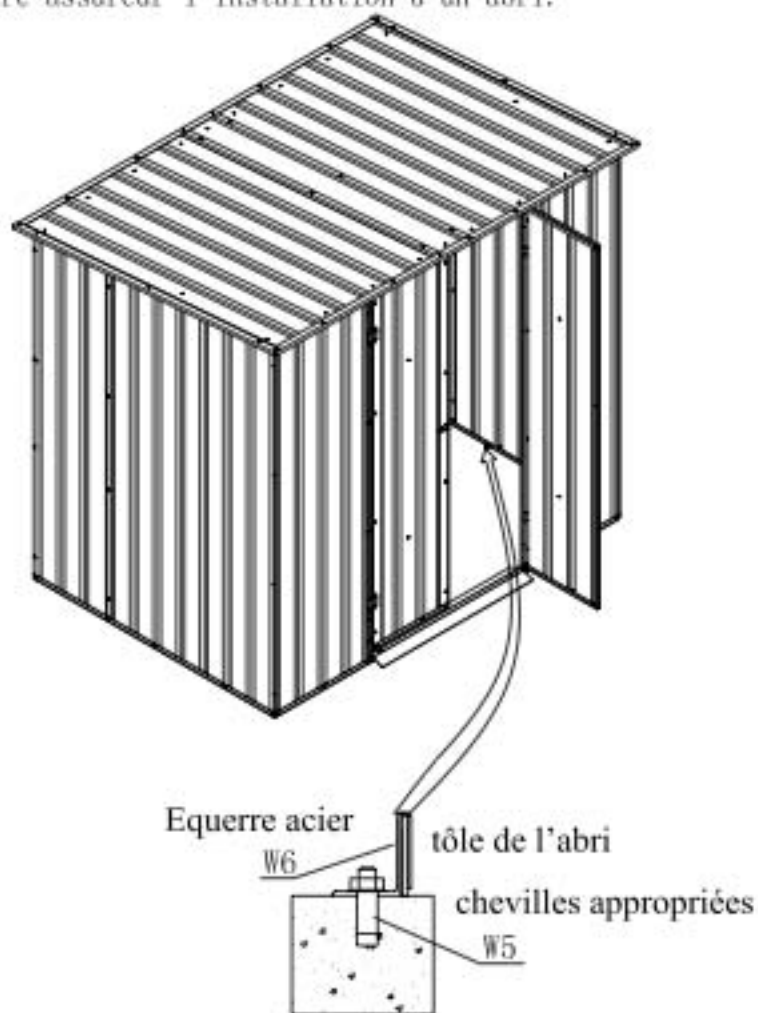

dessin	N° pièce	Nombre
	W2-2	1
	W3	12

13. Percer la dalle en béton et utiliser des vis et des chevilles appropriées pour fixer l'abri au sol en plusieurs points. Il est extrêmement important d'utiliser des chevilles robustes et appropriées et en quantité suffisante pour éviter la destruction de l'abri en cas de vent. La société FORESTA ne pourra pas être tenue responsable de la destruction de l'abri en cas de vent ou d'éléments extérieurs. Il est recommandé de signaler à votre assureur l'installation d'un abri.



dessin	N° pièce	Nombre
	W5	8
	W6	8