

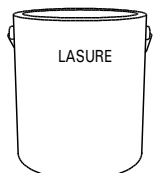

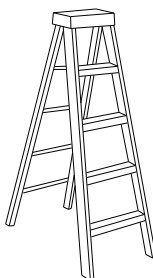

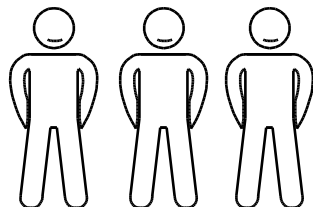

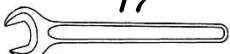
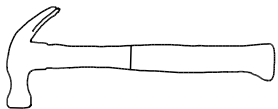
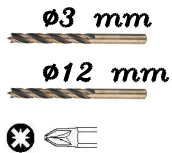
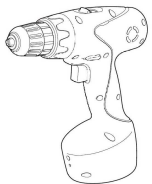
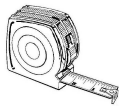
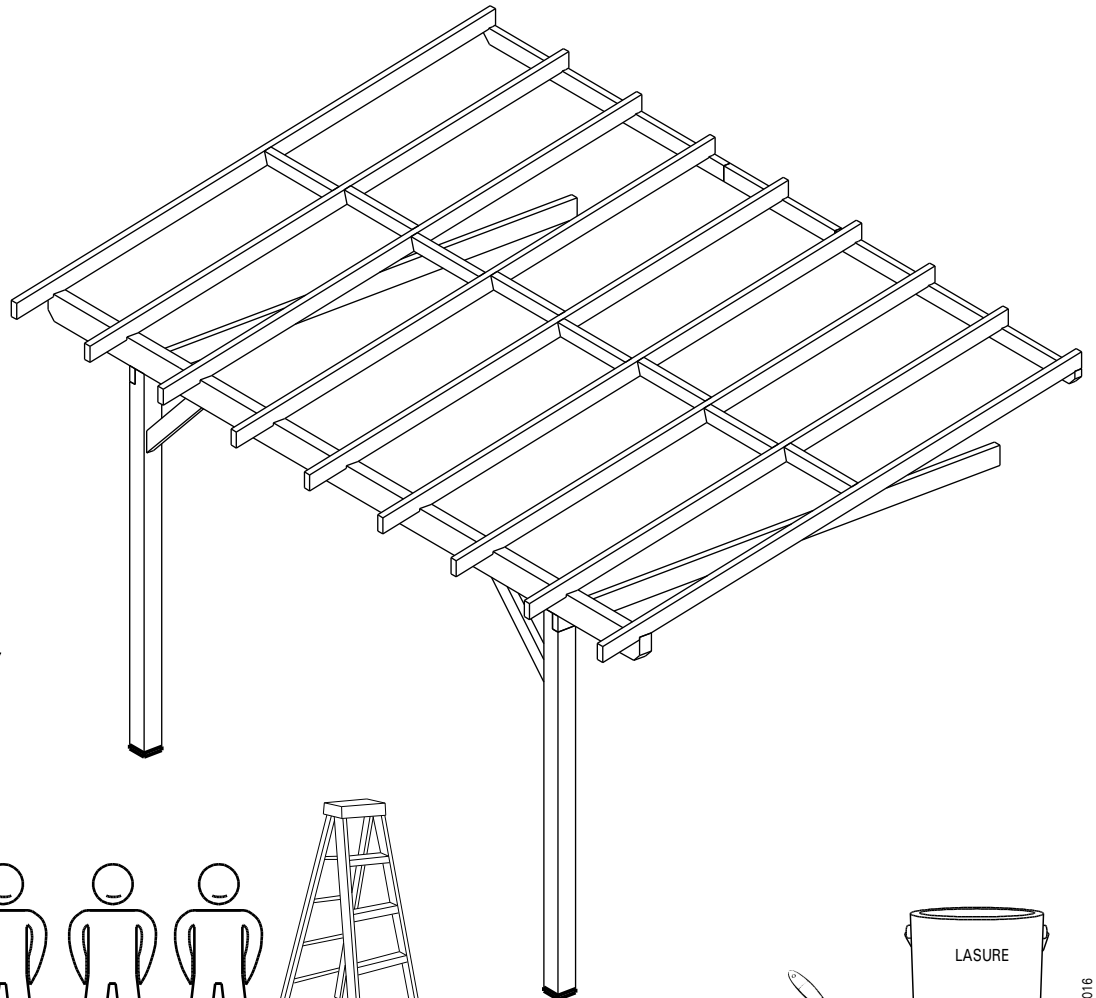
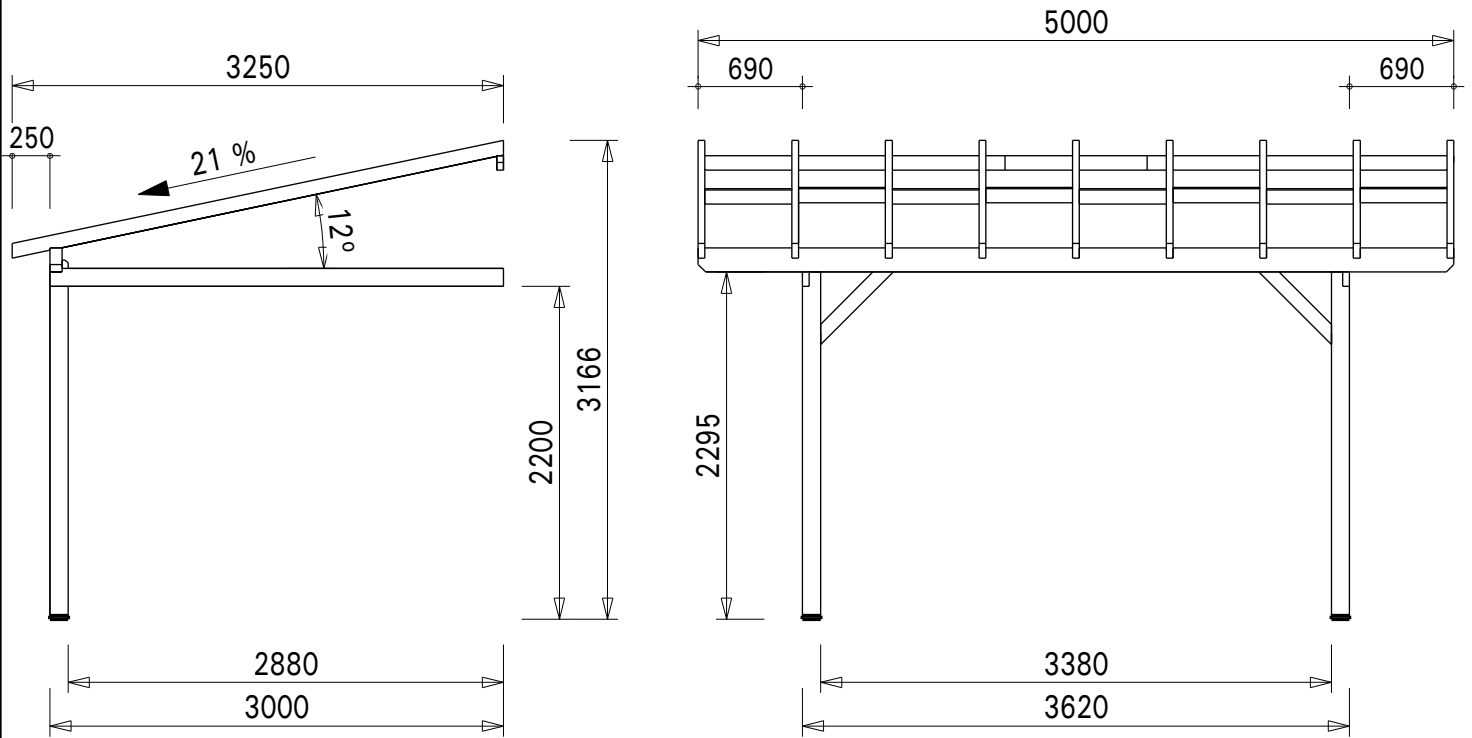

NOTICE DE MONTAGE de l'auvent monopente

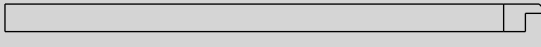
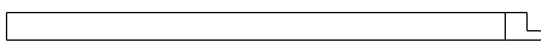
Réf. AM 3350 STL

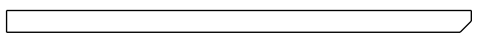
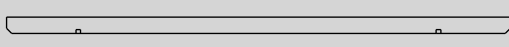

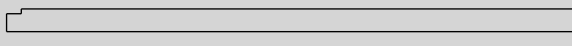





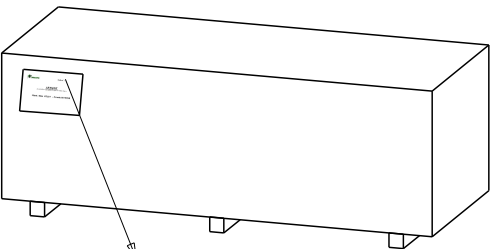

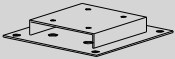
Vérifier que vous avez bien toutes les pièces avant d'effectuer le montage

Réf.	Qté.	Dessin pièce	Dimensions (en mm)			Demande sav	
			Observation	Qté.			
1	1		120	120	2353		
2	1		120	120	2353		
3	1		45	95	940		
4	2		45	95	2030		
5	1		80	160	5000		
6	2		45	95	753		
7	2		45	120	3000		
8	8		45	95	574		
9	9		45	95	3340		

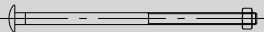
A compléter impérativement pour toute demande SAV et à envoyer par mail à sav@foresta.fr + photo des pièces abîmées

 <p>Colis n°: _____</p>	<p>AM 3350 STL</p> <p>Colis n°: _____</p>	NOM DU MAGASIN (où l'auvent a été acheté)	
		NOM DU CLIENT	
		PRENOM DU CLIENT	
		N° de téléphone	

Réf.	Qté.	Dessin pièce	Dimensions (en mm)			Demande sav	
						Observation	Qté.
q1	2		22	160	160		
q2	8			∅ 5	60		
q3	122			∅ 4	40		
q4	4			∅ 5	80		
q5	2			∅12	160		
q6	4			∅12	150		
q7	18		50	90	50		
q8	32				70		

A compléter impérativement pour toute demande SAV et à envoyer par mail à sav@foresta.fr + photo des pièces abîmées

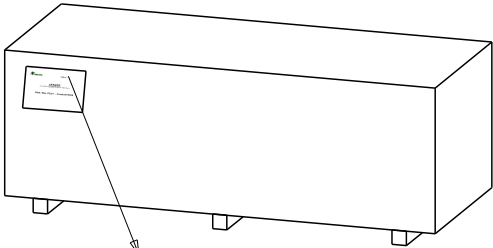
 <p>Colis n°: _____</p>	<p>AM 3350 STL</p> <p>Colis n°: _____</p>	NOM DU MAGASIN (où l'auvent a été acheté)	
		NOM DU CLIENT	
		PRENOM DU CLIENT	
		N° de téléphone	

Plan de soubassement

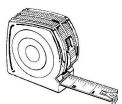
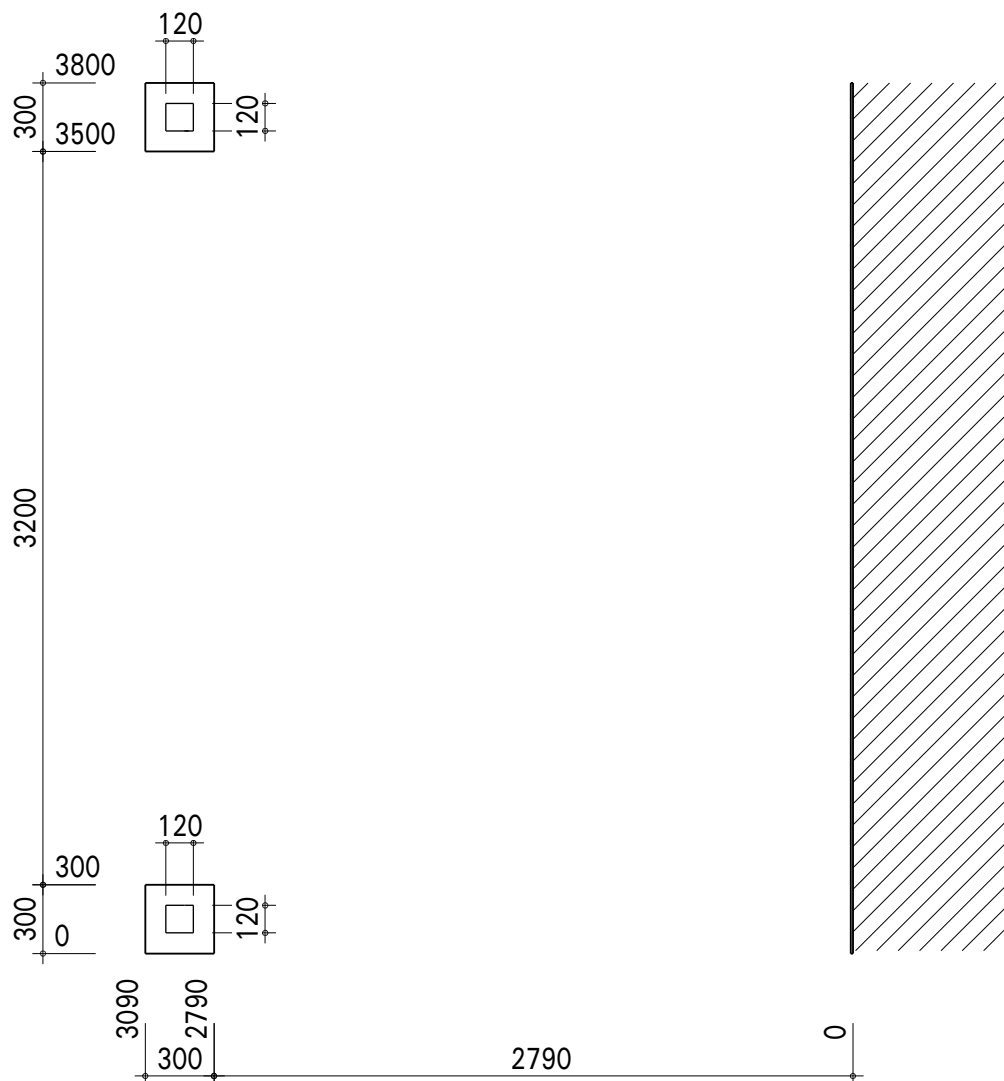

Tolérances à respecter (selon DTU 31.2):

- longueur et largeur: $\pm 0,01\text{m}$;
- équerrage: $\pm 0,01\text{m}$ mesuré sur 10m;
- arase: $\pm 0,01\text{m}$ sur une longueur de 10 mètres linéaires alignés ou non et de $\pm 2\text{mm}$ par mètre linéaire;
- rectitude de bords en plan: $\pm 5\text{mm}$.

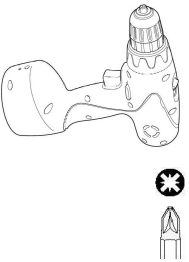
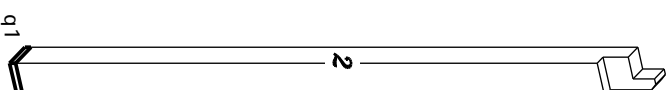
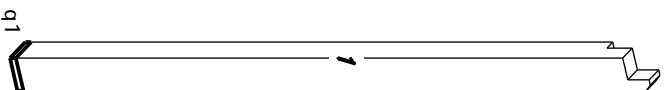

Réf.	Qté.	Dimensions (mm)		
1	1	120	120	2353
2	1	120	120	2353

q1	2	22	160	160
q2	8		∅ 5	60

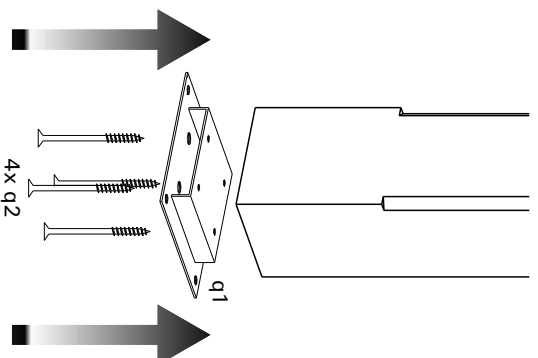



NOTICE DE MONTAGE de l'auvent monopente
Réf. AM 3350 STL

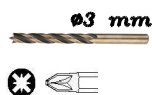
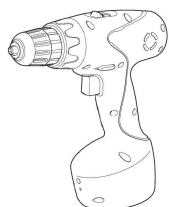
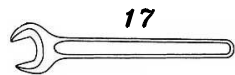
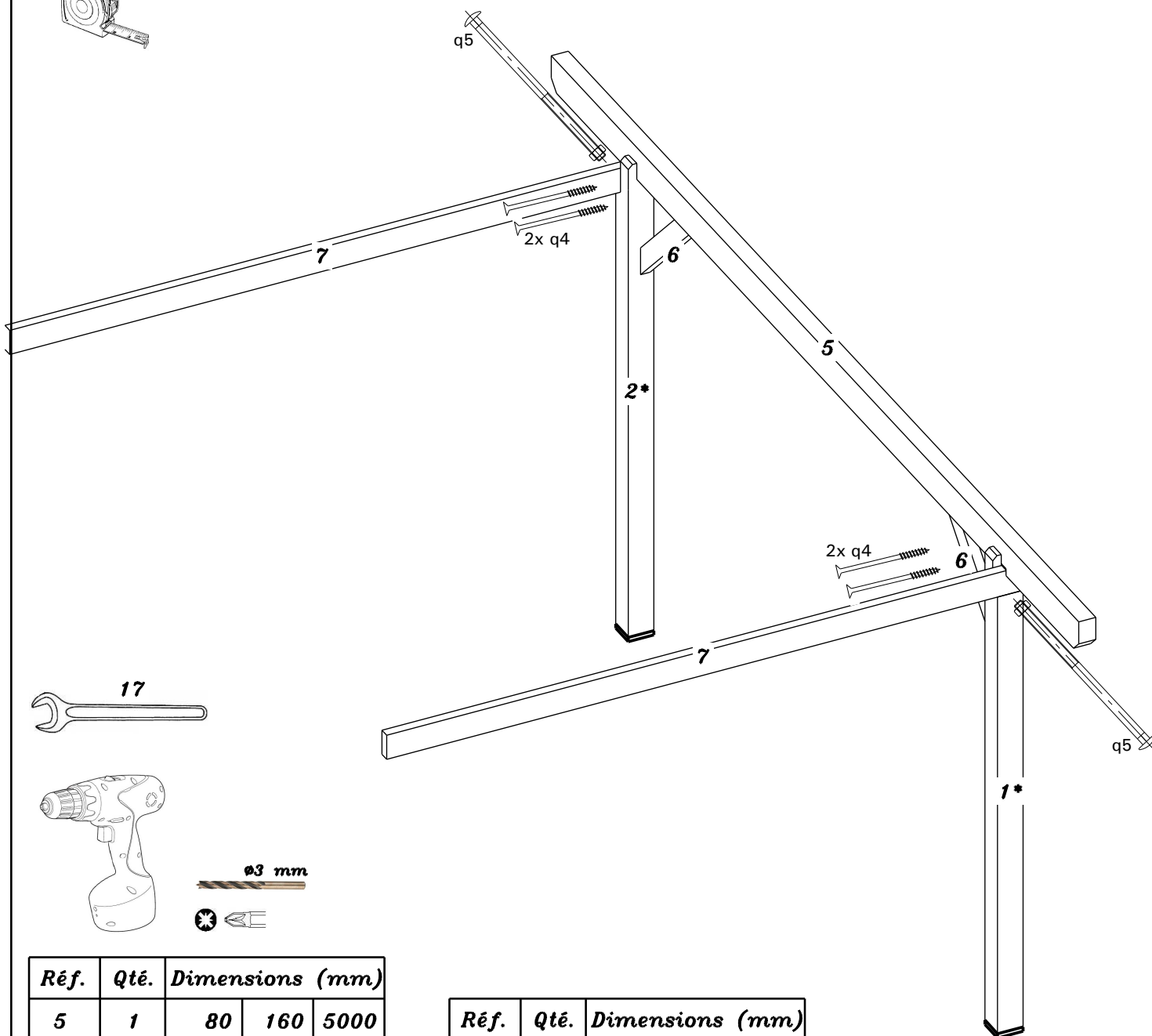
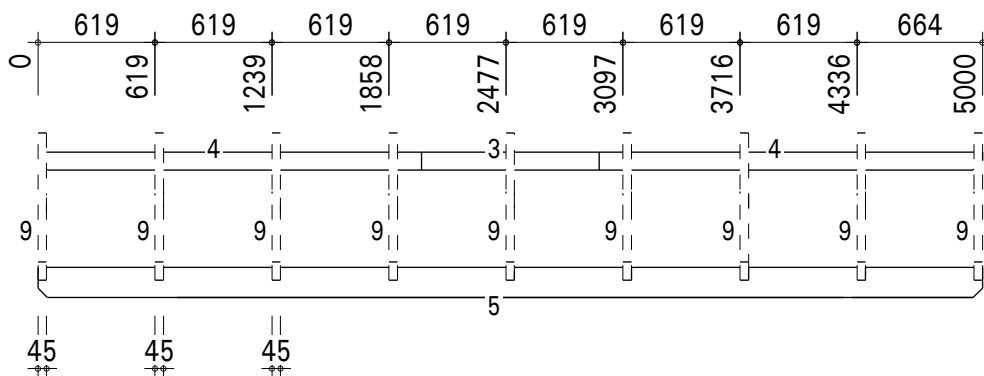

Réf.	Qté.	Dimensions (mm)		
5	1	80	160	5000
6	2	45	95	753
7	1	45	120	3000

Réf.	Qté.	Dimensions (mm)		
q4	4		ø 5	80
q5	2		ø12	160

NOTICE DE MONTAGE de l'aunut monopente
Réf. AM 3350 STL

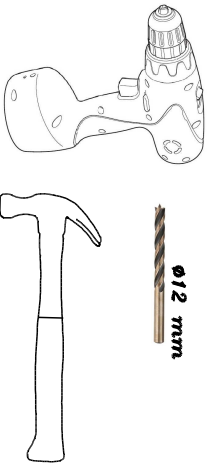
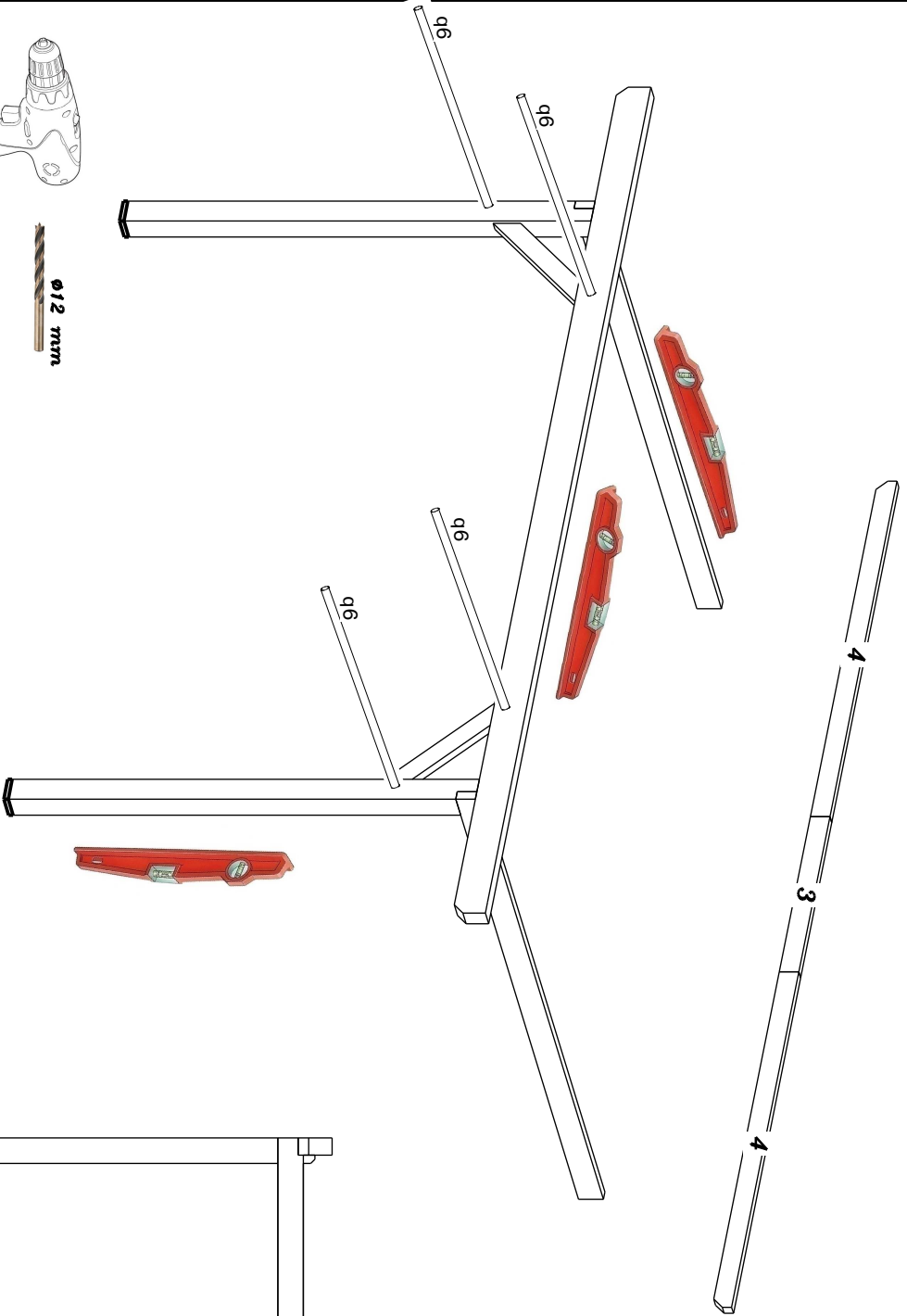

Réf.	Qté.	Dimensions (mm)		
3	1	45	95	940
4	2	45	95	2030

Réf.	Qté.	Dimensions (mm)	
q6	4	Ø12	150

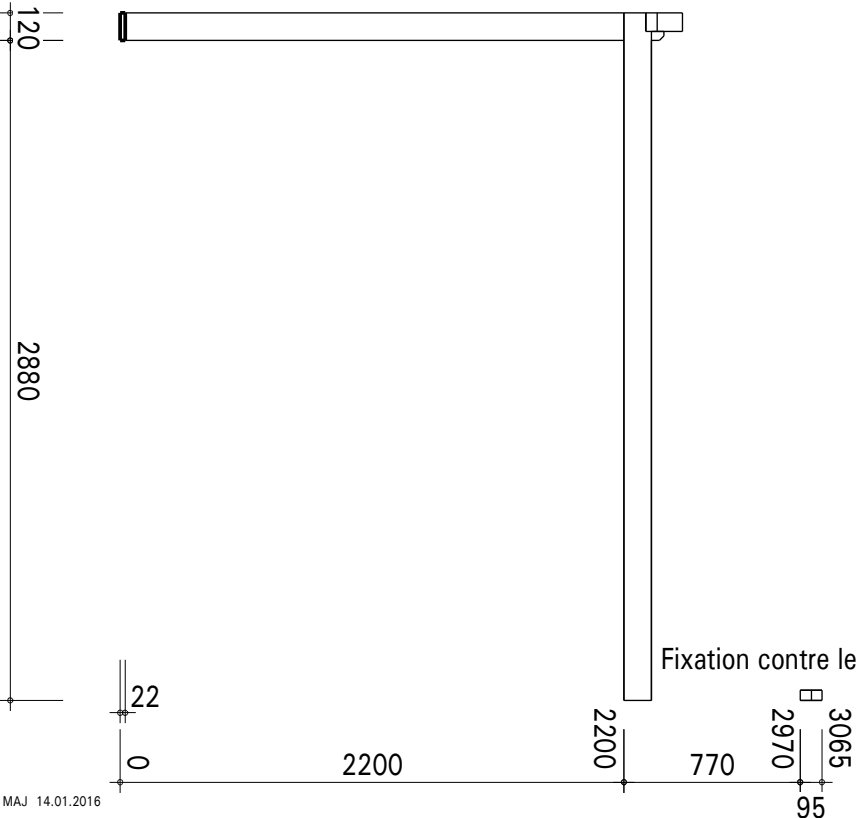

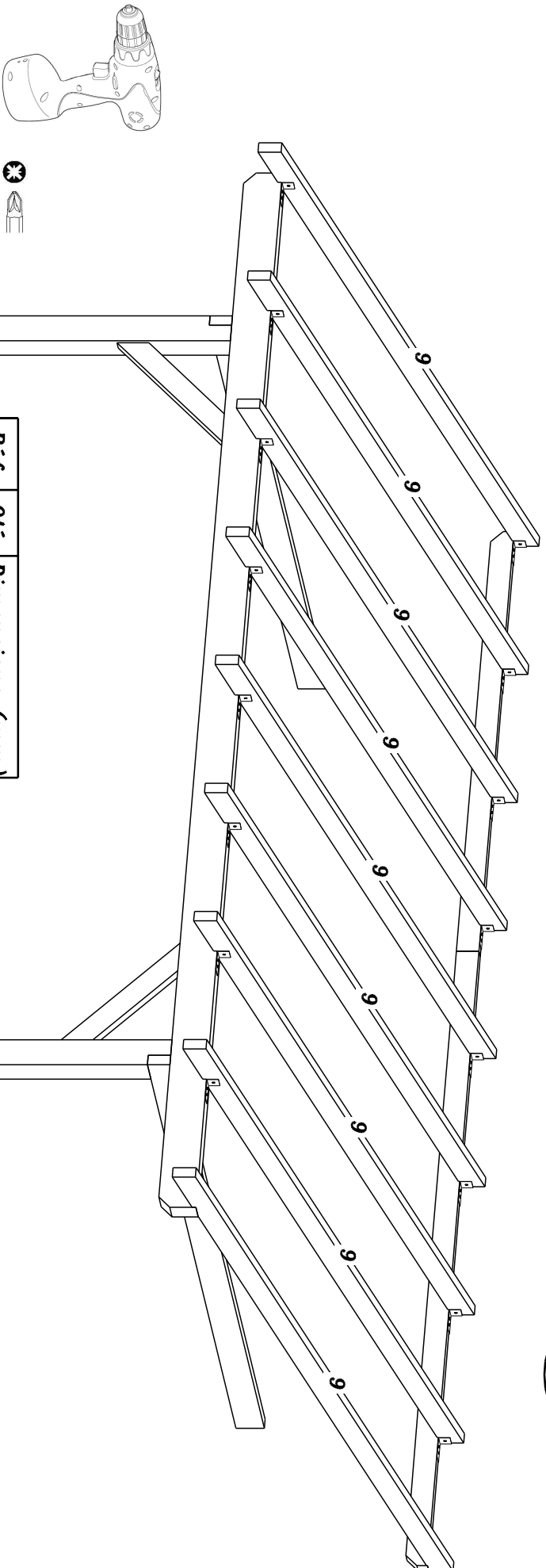
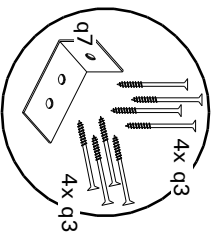
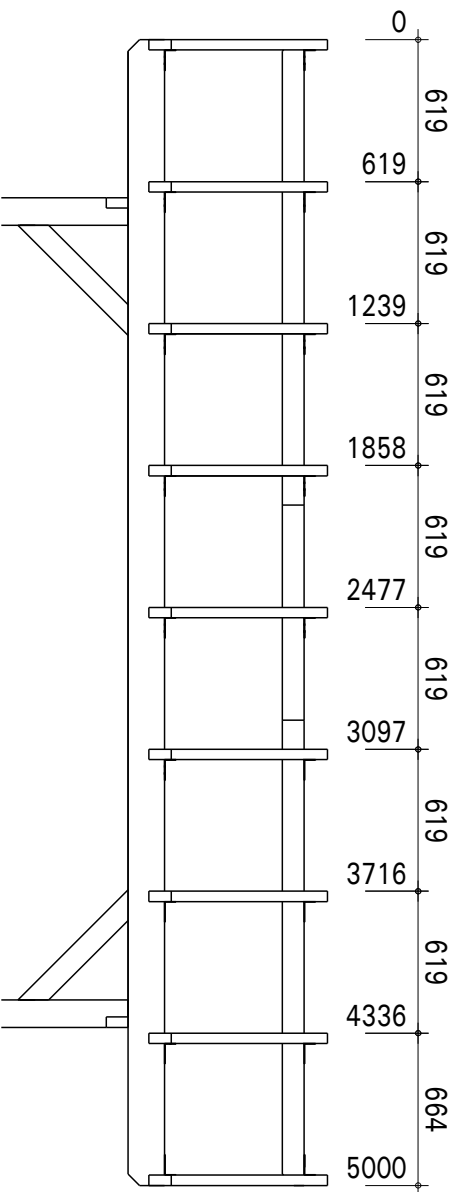

Réf.	Qté.	Dimensions (mm)		
9	9	45	95	3340

Réf.	Qté.	Dimensions (mm)		
q3	72		∅ 4	40
q7	18	50	90	50

Penser à prévenir votre assureur de l'existence de votre auvent pour garantie en cas de sinistre.

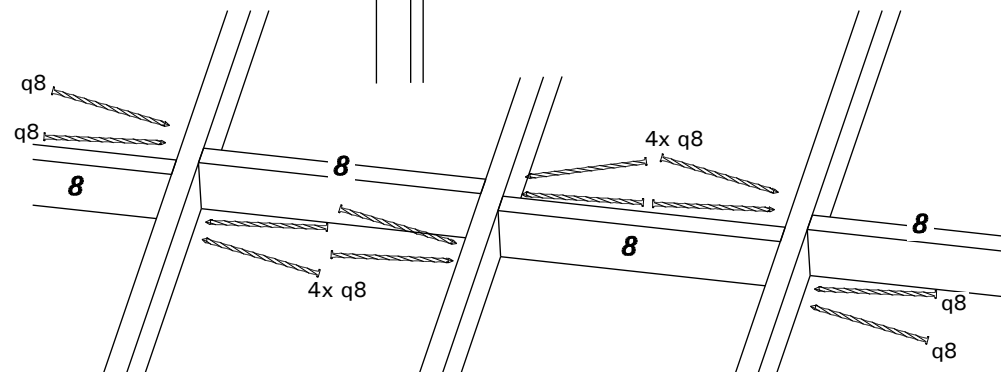
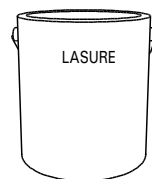
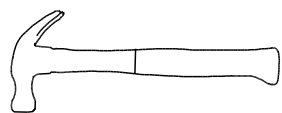
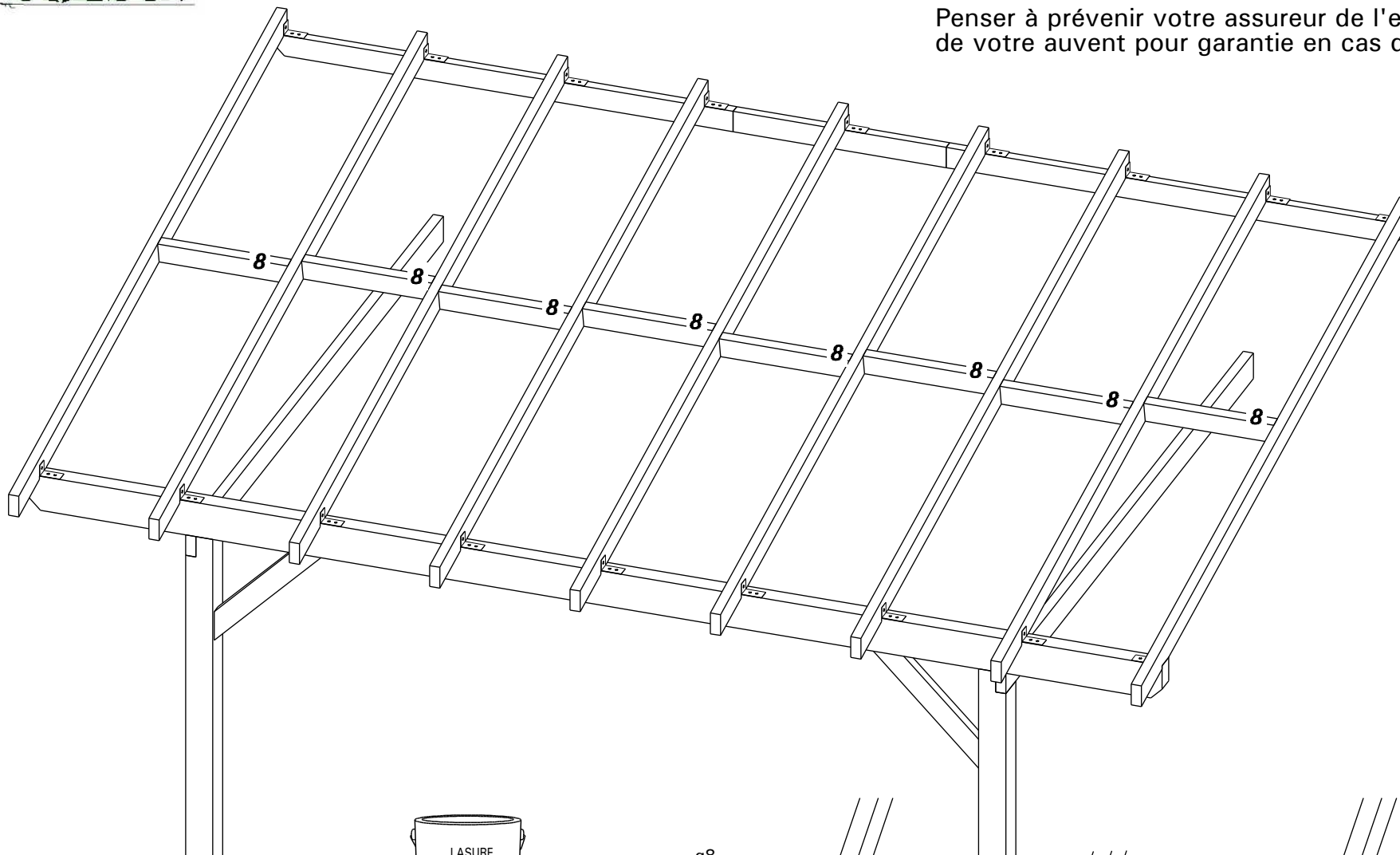

Réf.	Qté.	Dimensions (mm)		
8	8	45	95	574

Réf.	Qté.	Dimensions (mm)		
q8	32			70